



technical data

Individual Control Systems

air conditioning systems

VRV[®] III-S

VRV[®] III

VRV[®]-WII

TABLE OF CONTENTS

Individual control systems

1	Possible individual control systems	2
	Survey	4
2	BRC2C51 - Simplified remote control	5
	Explanation of buttons and functions	5
3	BRC3A61 - Simplified remote control for hotel applications ..	6
	Dimensional drawing	6
	Explanation of buttons and functions	7
4	BRC1D52 - Wired remote control	8
	Dimensional drawing	8
	Explanation of buttons and functions	9
5	BRC4C61,62,63,64 - Infrared remote control	11
	Dimensional drawing	11
	Explanation of buttons and functions	12
6	BRC7C62,67 - Infrared remote control	13
	Dimensional drawing	13
	Explanation of buttons and functions	14
7	BRC7F533F,532F - Infrared remote control	15
	Dimensional drawing	15
	Explanation of buttons and functions	16
8	BRC7E531W,530W - Infrared remote control	17
	Dimensional drawing	17
9	BRC7E63W,66 - Infrared remote control	18
	Dimensional drawing	18
	Explanation of buttons and functions	19
10	BRC7E618,619 - Infrared remote control	20
	Dimensional drawing	20
11	Survey of various control systems	21

1 Possible individual control systems

1



Simplified remote control - BRC2C51

- simple, compact and easy to operate unit
- suitable for use in hotel bedrooms

Operation buttons:

- ON / OFF
- Operation mode selection
- Fan speed control
- Temperature setting

Display

- Cool / heat changeover control
- Heat Recovery Ventilation (HRV) in operation
- Set temperature
- Operating mode
- Centralised control indication
- Fan speed
- Defrost / hot start
- Malfunction adjustment
- Operating mode selection
- Fan speed control
- Filter sign reset
- Inspection test / operation



Simplified remote control for hotel applications - BRC3A61

- compact, user friendly unit
- ideal for use in hotel bedrooms

Operation buttons:

- ON / OFF
- Fan speed control
- Temperature setting

Display

- Heat Recovery Ventilation (HRV) in operation
- Set temperature
- Operating mode
- Centralised control indication
- Fan speed
- Defrost / hot start
- Malfunction



Infrared remote control - BRC4C* / BRC7C*

Operation buttons:

- ON / OFF
- Timer mode start / stop
- Timer mode on / off
- Programmed time
- Temperature setting
- Air flow direction (FXHQ, FXFQ, FXCQ and FXAQ models only)
- Operating mode
- Fan speed control
- Filter sign reset
- Inspection test / operation

Display

- Operating mode
- Battery change
- Set temperature
- Air flow direction (FXHQ, FXFQ, FXCQ and FXAQ models only)
- Programmed time
- Inspection test / operation
- Fan speed

1 Possible individual control systems



BRC1D52

Wired remote control - BRC1D52

- Limit operation (min./max.): room temperature is controlled within adjustable upper and lower limits. Limit operation can be activated manually or by schedule timer
- Real time clock: indicates real time and day
- Schedule timer:
 - It is possible to programme a weekly schedule timer
 - It is possible to programme the remote control for each day of the week. Five day actions can be set as follows:
 - set point: unit is switched ON and normal operation is maintained
 - OFF: unit is switched OFF
 - limits: unit is switched ON and min./max. control (cf.limit operation for more details)
- Home leave (frost protection): during absence, the indoor temperature can be maintained at a certain level. This function can also switch the unit ON/OFF
- Different levels of disabled buttons can be selected as follows:
 - level 1: all buttons are accessible
 - level 2: all buttons are disabled except for:
 - ON/OFF
 - set temperature up/down
 - fan speed
 - cooling/heating mode
 - enable/disable schedule timer
 - air flow direction adjustment button
 - Level 3: all buttons are disabled except for:
 - ON/OFF
 - set temperature up/down
 - fan speed
- User friendly HRV function, thanks to the introduction of a button for ventilation mode and fan speed
- Constantly monitoring of the system for malfunctions in a total of 80 components
- Immediate display of fault location and condition
- Reduction of maintenance time and costs

Operation buttons:

- ON / OFF
- Timer mode start / stop
- Timer on / off
- Programmed time
- Temperature setting
- Air flow direction adjustment
- Operating mode selection
- Fan speed control
- Filter sign reset
- Inspection test / operation

Display

- Operating mode
- Heat Recovery Ventilation (HRV) in operation
- Cool / heat changeover control
- Centralised control indication
- Group control indication
- Set temperature
- Air flow direction
- Programmed time
- Inspection test / operation
- Fan speed
- Clean air filter
- Defrost / hot start
- Malfunction

1 Possible individual control systems

1 - 1 Survey

DESCRIPTION	FXZQ	FXFQ	FXCQ	FXKQ	FXDQ	FXDQ-N	FXSQ	FXMQ	FXAQ	FXHQ	FXUQ	FXLQ	FXNQ	
Wired remote control	BRC1D52													
Infrared remote control	cooling only	BRC7E531W	BRC7F533F	BRC7C67	BRC4C63	BRC4C64	BRC4C64	BRC4C64	BRC4C64	BRC7E619	BRC7E66	BRC7C529W	BRC4C64	BRC4C64
	heat pump	BRC7E530W	BRC7F532F	BRC7C62	BRC4C61	BRC4C62	BRC4C62	BRC4C62	BRC4C62	BRC7E618	BRC7E63W	BRC7C528W	BRC4C62	BRC4C62
Simplified remote control	-	-	-	-	BRC2C51	BRC2C51	BRC2C51	BRC2C51	-	-	-	-	BRC2C51	BRC2C51
Simplified remote control for hotel use	-	-	-	-	BRC3A61	BRC3A61	BRC3A61	BRC3A61	-	-	-	-	BRC3A61	BRC3A61

1

2 BRC2C51 - Simplified remote control

2 - 1 Explanation of buttons and functions

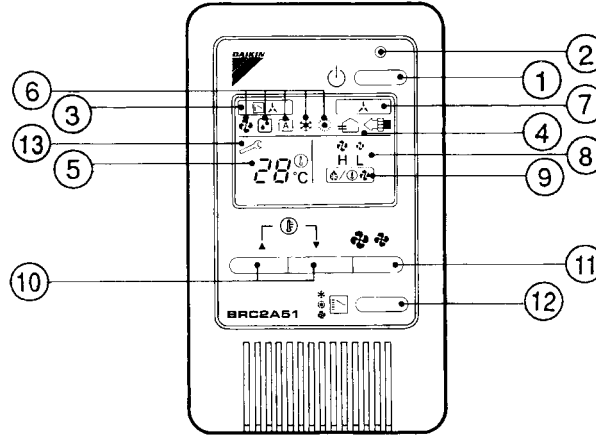

1	ON/OFF BUTTON	8	DISPLAY ' ' (FAN SPEED)
	Press the button and the system will start. Press the button again and the system will stop.		The display shows the fan speed: "HIGH" or "LOW".
2	OPERATION LAMP (RED)	9	DISPLAY ' ' (DEFROST/HOT START)
	The lamp lights up during operation and blinks in case of stop due to malfunction.		Indicates that defrost or hot start (during which the fan is stopped till the temperature of air supply rises enough at the start of a heating run) is in progress.
3	DISPLAY ' ' (CHANGEOVER UNDER CONTROL)	10	TEMPERATURE SETTING BUTTON
	It is impossible to changeover heat/cool with the remote controller when it shows this display. (As for details, see "SETTINGS OF MASTER REMOTE CONTROL" in the operation manual attached to the indoor unit).		Use this button for SETTING TEMPERATURE of the thermostat. ▲; Each press raises the set temperature by 1°C. ▼; Each press lowers the set temperature by 1°C. The variable temperature range is 16°C to 32°C.
4	DISPLAY " , " "; "OPTION" (VENTILATION / AIR CLEANING)	11	FAN SPEED CONTROL BUTTON
	This display shows that the total heat exchange unit and the air cleaning unit are in operation. (These are optional accessories).		Press this button to select the fan speed, HIGH or LOW, of your choice.
5	DISPLAY ' ' (SET TEMPERATURE)	12	OPERATION MODE SELECTOR BUTTON
	This display shows the set temperature. Only given during a cooling or heating operation.		Press this button to select OPERATION MODE.
6	DISPLAY ' ' (OPERATION MODE)	13	DISPLAY ' ' (MALFUNCTION)
	This display shows the current OPERATION MODE. ☀ is not available with outdoor units specially designed for cooling only. ☀ is reserved only for outdoor units capable of heat recovery.		Indicates malfunction and blinks if the unit stops operating due to the malfunction. (As for details, see "TROUBLE SHOOTING" in the operation manual attached to the indoor unit.)
7	DISPLAY ' ' (UNDER CENTRALIZED CONTROL)		
	When this display shows, the system is UNDER CENTRALIZED CONTROL. (This is not a standard specification)		

NOTE

- 1 Please note that the display shows all indications for the purpose of explanation only. This is contrary to actual running situations.

3 BRC3A61 - Simplified remote control for hotel applications

3 - 1 Dimensional drawing

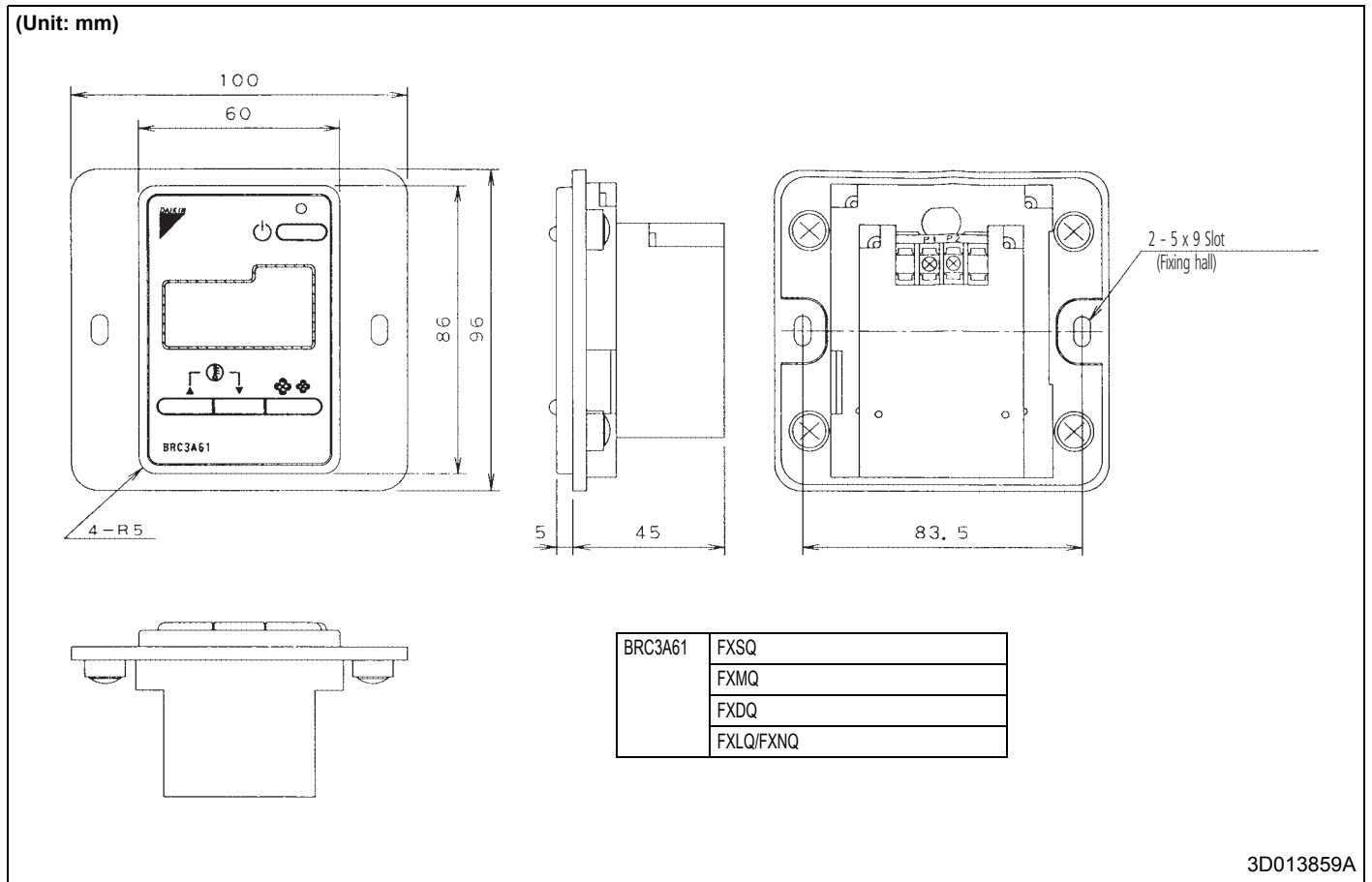

3

3 BRC3A61 - Simplified remote control for hotel applications

3 - 2 Explanation of buttons and functions

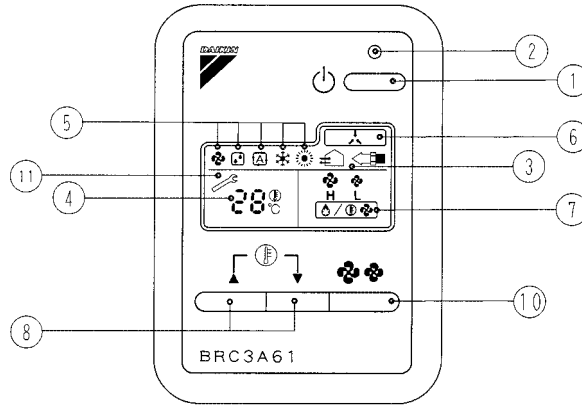

1	ON/OFF BUTTON	7	DISPLAY '🌀🌀' (FAN SPEED)
	Press the button and the system will start. Press the button again and the system will stop.		The display shows the set fan speed: 'HIGH' or 'LOW'.
2	OPERATION LAMP (RED)	8	DISPLAY '🔥❄️' (DEFROST/HOT START)
	The lamp lights up during operation or blinks if a malfunction occurs.		Indicates that defrost or hot start (during which the fan is stopped till the temperature of air supply rises enough at the start of a heating run) is in progress.
3	DISPLAY '🏠🌀' (VENTILATION / AIR CLEANING)	9	TEMPERATURE SETTING BUTTON
	This display shows that the total heat exchange unit is in operation. (These is an optional accessory).		Use this button for SETTING TEMPERATURE of the thermostat. ▲; Each press raises the set temperature by 1°C. ▼; Each press lowers the set temperature by 1°C. The variable temperature range is 16°C tot 32°C.
4	DISPLAY '🌡️' (SET TEMPERATURE)	10	FAN SPEED CONTROL BUTTON
	This display shows the set temperature. Only given during a cooling or heating operation.		Press this button to select the fan speed, HIGH or LOW, of your choice.
5	DISPLAY '🌀🏠🌡️🌞🌙' (OPERATION MODE)	11	DISPLAY '🚨' (MALFUNCTION)
	This display shows the current OPERATION MODE. 🌞 is not available with outdoor units specially designed for cooling only. 🌙 is reserved only for heat recovery outdoor units.		Indicates malfunction and blinks if the unit stops operating due to the malfunction. (As for details, see "TROUBLE SHOOTING" in the operation manual attached to the indoor unit.)
6	DISPLAY '🏠' (UNDER CENTRALIZED CONTROL)		
	When this display shows, the system is UNDER CENTRALIZED CONTROL. (This is not a standard specification)		

NOTES

- Please note that the display shows all indications for the purpose of explanation only. This is contrary to actual running situations.
- This remote controller does not have "AIR FLOW DIRECTION ADJUST BUTTON." Don't operate the flap adjusting air flow direction by your hand. (FXFQ, FXCQ, FXAQ, FXKQ)

4 BRC1D52 - Wired remote control

4 - 1 Dimensional drawing

(Unit: mm)

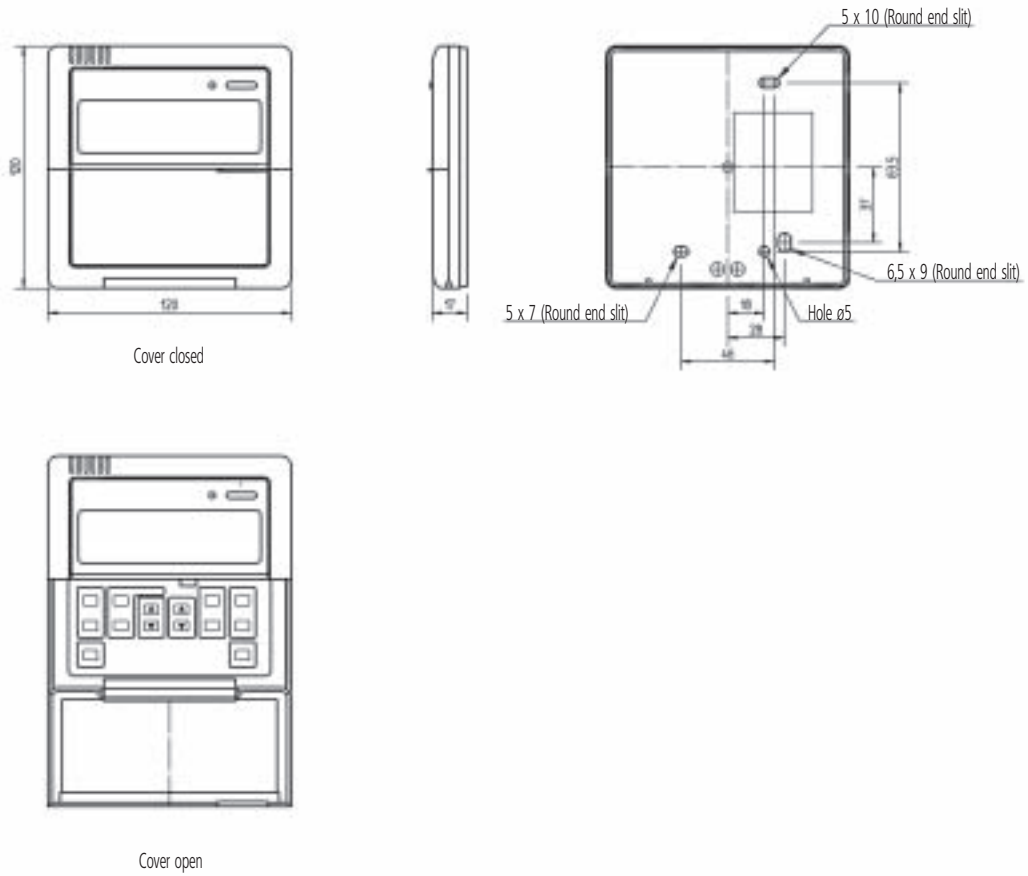

3TW23651-2

4 BRC1D52 - Wired remote control

4 - 2 Explanation of buttons and functions

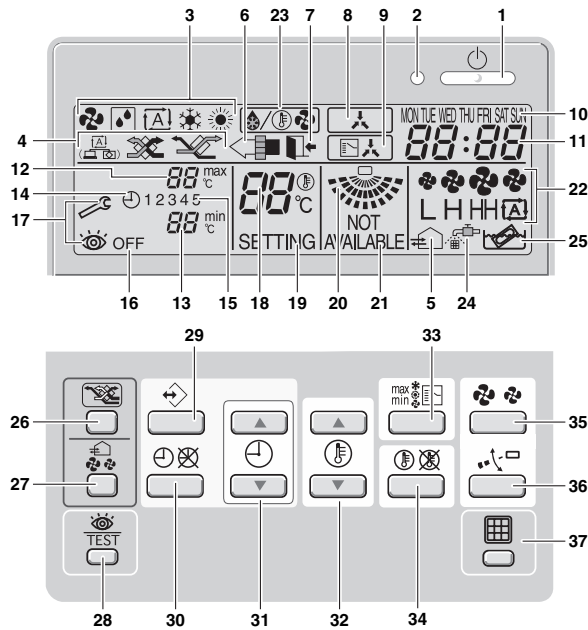







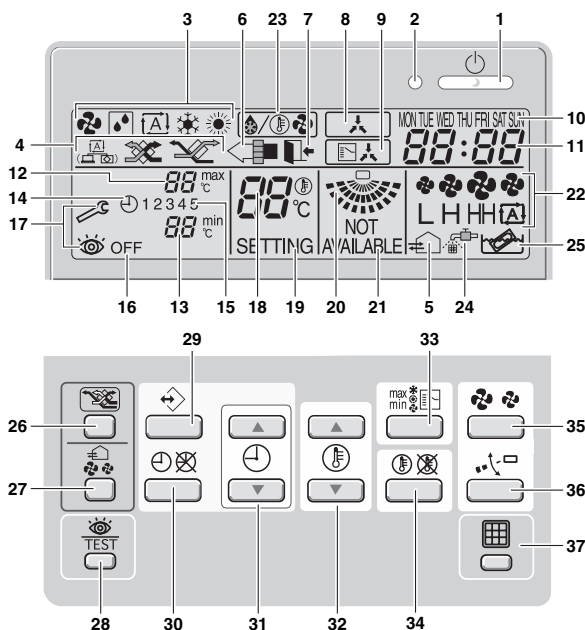





1	ON/OFF BUTTON ' '	13	MINIMUM SET TEMPERATURE ' 8.8 min °C '	
	Press the ON/OFF button to start or stop the system.		The minimum set temperature indicates the minimum set temperature when in limit operation.	
2	OPERATION LAMP ' ○ '	14	SCHEDULE TIMER ICON ' '	
	The operation lamp lights up during operation or blinks if a malfunction occurs.		This icon indicates that the schedule timer is enabled.	
3	OPERATION MODE ICON ' '	15	ACTION ICONS ' 1 2 3 4 5 '	
	These icons indicate the current operation mode (FAN, DRY, AUTOMATIC, COOLING, HEATING).		These icons indicate the actions for each day of the schedule timer.	
4	VENTILATION MODE ICON ' '	16	OFF ICON ' OFF '	
	These icons indicate the current ventilation mode (HRV only) (AUTOMATIC, HEAT EXCHANGE, BYPASS).		This icon indicates that the OFF action is selected when programming the schedule timer.	
5	VENTILATION ICON ' '	17	INSPECTION REQUIRED ' ' and ' '	
	The ventilation icon appears when the ventilation is adjusted with the ventilation amount button (HRV only). Simultaneously, the ventilation amount is indicated by the fan speed icon (see 22).		These icons indicate that inspection is required. Consult your installer.	
6	AIR CLEANING ICON ' '	18	SET TEMPERATURE DISPLAY ' 27.0 °C '	
	This icon indicates that the air cleaning unit (option) is operational.		This indicates the current set temperature of the installation (not shown in LIMIT operation or in FAN or DRY mode).	
7	LEAVE HOME ICON ' '	19	SETTING ' SETTING '	
	The leave home icon shows the status of the leave home function.		Not used, for service purposes only.	
	ON Leave home is enabled		20	AIR FLOW DIRECTION ICON ' '
	FLASHING Leave home is active			This icon indicates the air flow direction (only for installations with motorised air flow flaps).
OFF Leave home is disabled	21	NOT AVAILABLE ' NOT AVAILABLE '		
		This is displayed whenever a non-installed option is addressed or a function is not available.		
8	EXTERNAL CONTROL ICON ' '	22	FAN SPEED ICON ' '	
	This icon indicates that another controller with higher priority is controlling or disabling your installation.		This icon indicates the set fan speed.	
9	CHANGE-OVER UNDER CENTRALISED CONTROL ICON ' '	23	DEFROST/HOTSTART MODE ICON ' '	
	This icon indicates that the change-over of the installation is under centralised control assigned to another indoor unit or optional cool/heat selector connected to the outdoor unit (= master remote controller).		This icon indicates that the defrost/hotstart mode is active.	
10	DAY OF THE WEEK INDICATOR ' MON TUE WED THU FRI SAT SUN '	24	AIR FILTER CLEANING TIME ICON ' '	
	The day of the week indicator shows the current week day (or the set day when reading or programming the schedule timer).		This icon indicates the air filter must be cleaned. Refer to the manual of the indoor unit.	
11	CLOCK DISPLAY ' 88:88 '	25	ELEMENT CLEANING TIME ICON ' '	
	The clock display indicates the current time (or the action time when reading or programming the schedule timer).		This icon indicates the element must be cleaned (HRV only).	
12	MAXIMUM SET TEMPERATURE ' 8.8 max °C '	26	VENTILATION MODE BUTTON ' '	
	The maximum set temperature indicates the maximum set temperature when in limit operation.		The ventilation mode button operates the HRV; refer to the HRV manual for more details.	

4 BRC1D52 - Wired remote control

4 - 2 Explanation of buttons and functions



27	VENTILATION AMOUNT BUTTON '  '	33	OPERATION CHANGE/MIN-MAX BUTTON '  '
	This button sets the ventilation amount; refer to the HRV manual for more details.		This button is a multi-purpose button. Depending on the previous manipulations of the user, it can have following functions: 1 select the operation mode of the installation (FAN, DRY, AUTOMATIC, COOLING, HEATING) 2 toggle between minimum temperature and maximum temperature when in limit operation
28	INSPECTION/TEST OPERATION BUTTON '  TEST '	34	SETPOINT/LIMIT BUTTON '  '
	Not used, for service purposes only.		This button toggles between setpoint, limit operation or 'OFF' (programming mode only).
29	PROGRAMMING BUTTON '  '	35	FAN SPEED BUTTON '  '
	This button is a multi-purpose button. Depending on the previous manipulations of the user, the programming button can have various functions.		This button toggles between L (Low), H (High), HH (very High),  (Automatic).
30	SCHEDULE TIMER BUTTON '  '	36	AIR FLOW DIRECTION ADJUST BUTTON '  '
	This button enables or disables the schedule timer.		This button enables to adjust the air flow direction.
31	TIME ADJUST BUTTON '  '	37	AIR FILTER CLEANING TIME ICON RESET BUTTON '  '
	These buttons are used to adjust the clock or, when in programming mode, to adjust the programmed action time. Both buttons have an auto-repeat function.		This button is used to reset the air filter cleaning time icon.
32	TEMPERATURE ADJUST BUTTON '  '		
	These buttons are used to adjust the current setpoint or, when in programming mode, to adjust the programmed setpoint temperature (step = 1°C). Both buttons are also used to adjust the day of the week.		

5 BRC4C61,62,63,64 - Infrared remote control

5 - 1 Dimensional drawing

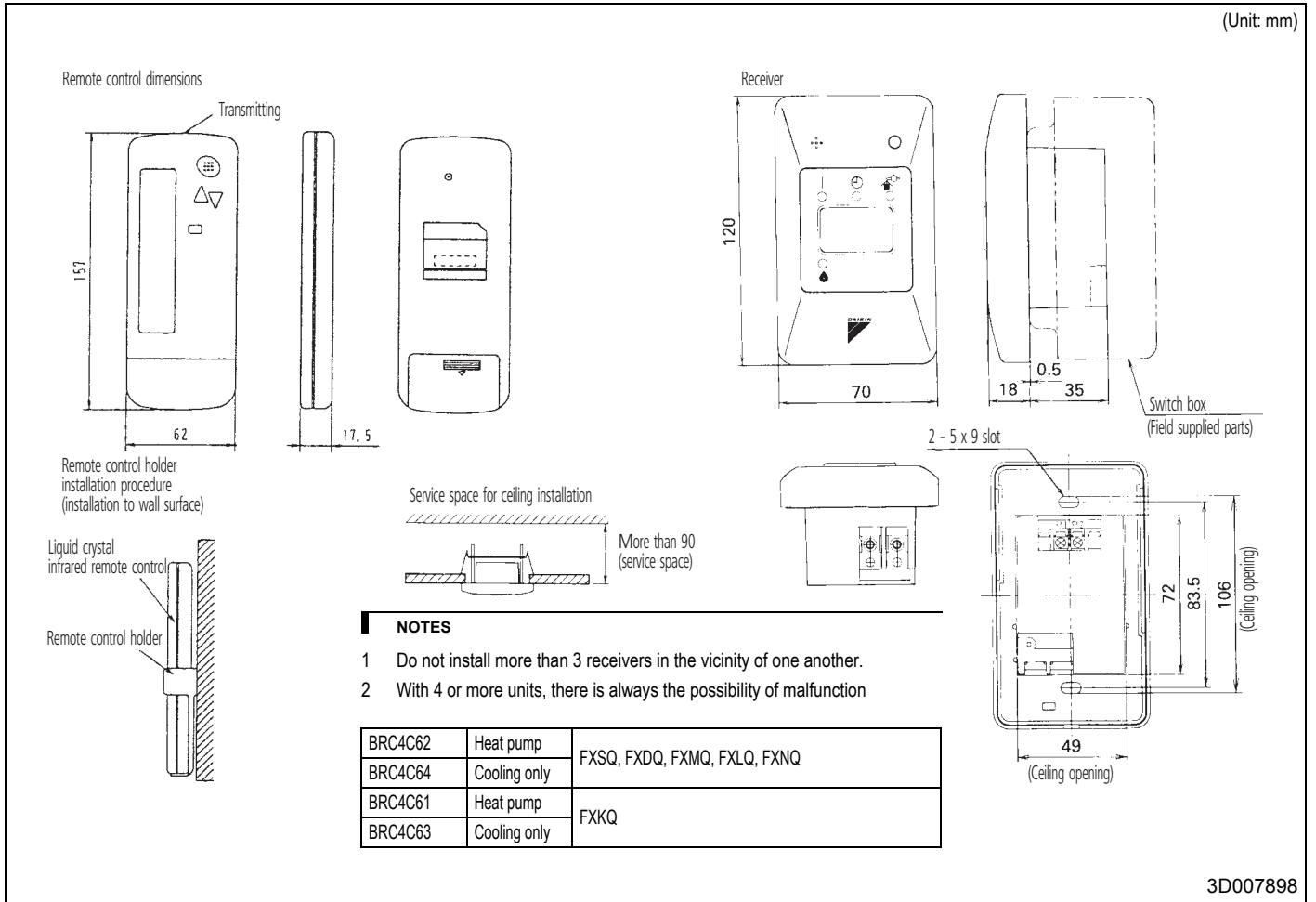

5 BRC4C61,62,63,64 - Infrared remote control

5 - 2 Explanation of buttons and functions

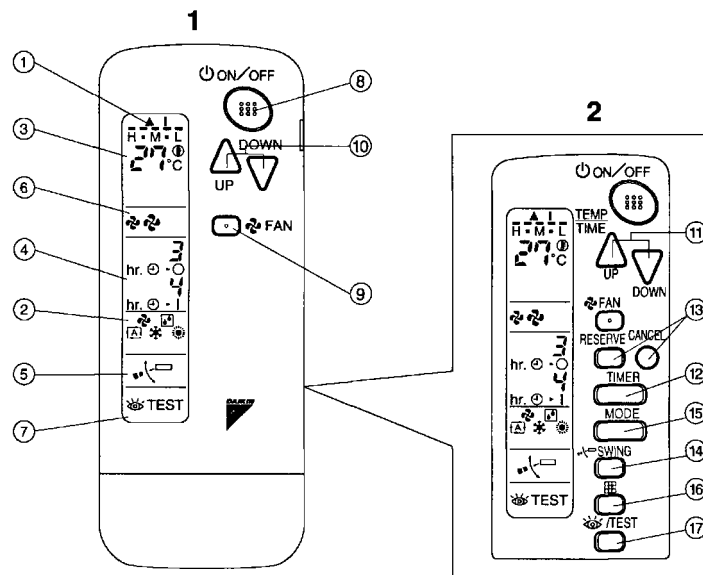

1	DISPLAY '7' (SIGNAL TRANSMISSION) This lights up when a signal is being transmitted.	13	TIMER RESERVE/CANCEL BUTTON
2	DISPLAY 'A', 'M', 'L', 'C', 'H', 'M', 'L', 'C' (OPERATION MODE) This display shows the current OPERATION MODE. For cooling only type, 'A' (Auto) and 'H' (Heating) are not installed.	14	AIR FLOW DIRECTION ADJUST BUTTON (BRC4C61,63 only)
		15	OPERATION MODE SELECTOR BUTTON Press this button to select OPERATION MODE.
3	DISPLAY 'TEMP' (SET TEMPERATURE) This display shows the set temperature.	16	FILTER SIGN RESET BUTTON
		17	INSPECTION/TEST OPERATION BUTTON This button is used only by qualified service persons for maintenance purposes.
4	DISPLAY 'hr.' (PROGRAMMED TIME) This display shows PROGRAMMED TIME of the system start or stop.	18	EMERGENCY OPERATION SWITCH This switch is readily used if the remote control does not work.
	5	DISPLAY 'AIR FLOW FLAP' (BRC4C61,63 only)	19
6	DISPLAY 'FAN SPEED' The display shows the set fan speed.	20	OPERATING INDICATOR LAMP (RED) This lamp stays lit while the air conditioner runs. It flashes when the unit is in trouble.
	7	DISPLAY 'TEST' (INSPECTION/TEST OPERATION) When the INSPECTION/TEST OPERATION BUTTON is pressed, the display shows the system mode is in.	21
8		ON/OFF BUTTON Press the button and the system will start. Press the button again and the system will stop.	22
	9	FAN SPEED CONTROL BUTTON Press this button to select the fan speed, HIGH or LOW, of your choice.	23
10		TEMPERATURE SETTING BUTTON Use this button for SETTING TEMPERATURE. (Operates with the front cover of the remote control closed.)	24
	11	PROGRAMMING TIME BUTTON Use this button for programming "START and/or STOP" time. (Operates with the front cover of the remote control closed.)	25
12		TIMER MODE START/STOP BUTTON	

NOTES

- Please note that the display shows all indications for the purpose of explanation only. This is contrary to actual running situations.
- Figure 2 shows the remote control with the front cover opened.

6 BRC7C62,67 - Infrared remote control

6 - 1 Dimensional drawing

(Unit: mm)

Remote control dimensions

Remote control holder installation procedure (installation to wall surface)

Receiver installation procedure

Receiver detail

BRC7C62	Heat pump	FXCQ
BRC7C67	Cooling only	

6 BRC7C62,67 - Infrared remote control

6 - 2 Explanation of buttons and functions

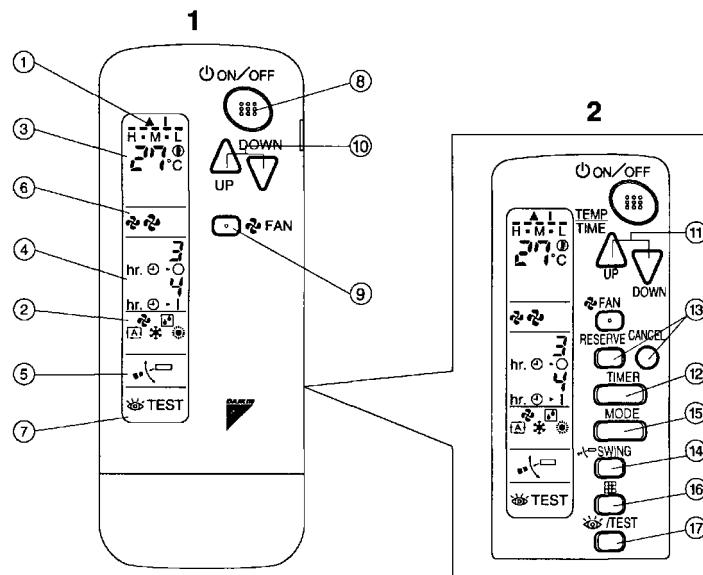

1	DISPLAY '7' (SIGNAL TRANSMISSION)	13	TIMER RESERVE/CANCEL BUTTON
	This lights up when a signal is being transmitted.	14	AIR FLOW DIRECTION ADJUST BUTTON
2	DISPLAY 'A', 'M', 'L', 'C', 'H', 'M', 'L', 'C' (OPERATION MODE)	15	OPERATION MODE SELECTOR BUTTON
	This display shows the current OPERATION MODE. For cooling only type, 'A' (Auto) and 'H' (Heating) are not installed.	16	FILTER SIGN RESET BUTTON
3	DISPLAY 'TEMP' (SET TEMPERATURE)	17	INSPECTION/TEST OPERATION BUTTON
	This display shows the set temperature.	18	EMERGENCY OPERATION SWITCH
4	DISPLAY '3hr', '5hr' (PROGRAMMED TIME)	19	RECEIVER
	This display shows PROGRAMMED TIME of the system start or stop.	20	This receives the signals from the remote control.
5	DISPLAY 'AIR FLOW' (AIR FLOW FLAP)	21	OPERATING INDICATOR LAMP (RED)
	6	DISPLAY 'FAN' (FAN SPEED)	22
7		DISPLAY 'TEST' (INSPECTION/TEST OPERATION)	23
	8	ON/OFF BUTTON	24
9		FAN SPEED CONTROL BUTTON	25
	10	TEMPERATURE SETTING BUTTON	26
Use this button for SETTING TEMPERATURE. (Operates with the front cover of the remote control closed.)		27	DEFROST LAMP (ORANGE)
11	PROGRAMMING TIMER BUTTON	28	Lights up when the defrosting operation has started. (For straight cooling type this lamp does not turn on.)
	Use this button for programming "START and/or STOP" time. (Operates with the front cover of the remote control closed.)	29	FAN/AIR CONDITIONING SELECTOR SWITCH
12	TIMER MODE START/STOP BUTTON	30	Set the switch to "FAN" (FAN) for FAN and "A/C" (A/C) for HEAT or COOL.
		31	COOL/HEAT CHANGEOVER SWITCH
		32	Set the switch to "COOL" (COOL) for COOL and "HEAT" (HEAT) for HEAT.

NOTES

- Please note that the display shows all indications for the purpose of explanation only. This is contrary to actual running situations.
- Figure 2 shows the remote control with the front cover opened.

7 BRC7F533F,532F - Infrared remote control

7 - 1 Dimensional drawing

FXFQ-P

Remote control dimensions

Transmitting part

Receiver installation procedure

Pipe connection side

Drain connection side

Receiver

Decoration panel

Remote control holder installation procedure (installation to wall surface)

Liquid crystal - remote control (wireless)

Remote control holder

Receiver detail

Wireless remote control kit for eacht decoration panel

Wireless remote control kit	Decoration panel
BRC7F532F BRC7F533F	BYCQ140CW1

3D056851

7 BRC7F533F,532F - Infrared remote control

7 - 2 Explanation of buttons and functions

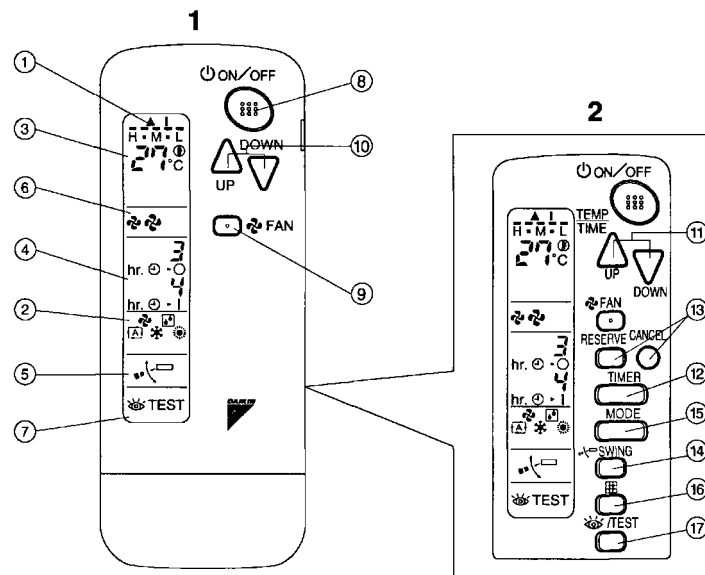

1	DISPLAY '7' (SIGNAL TRANSMISSION)	13	TIMER RESERVE/CANCEL BUTTON
	This lights up when a signal is being transmitted.	14	AIR FLOW DIRECTION ADJUST BUTTON
2	DISPLAY 'H-M-C' (OPERATION MODE)	15	OPERATION MODE SELECTOR BUTTON
	This display shows the current OPERATION MODE. For cooling only type, 'H-M-C' (Auto) and 'C' (Heating) are not installed.	16	FILTER SIGN RESET BUTTON
3	DISPLAY '27.0' (SET TEMPERATURE)	17	INSPECTION/TEST OPERATION BUTTON
	This display shows the set temperature.	18	EMERGENCY OPERATION SWITCH
4	DISPLAY '3hr 30min' (PROGRAMMED TIME)	19	RECEIVER
	This display shows PROGRAMMED TIME of the system start or stop.	20	OPERATING INDICATOR LAMP (RED)
5	DISPLAY '▲□' (AIR FLOW FLAP)	21	TIMER INDICATOR LAMP (GREEN)
	DISPLAY '3' (FAN SPEED)	22	AIR FILTER CLEANING TIME INDICATOR LAMP (RED)
6	The display shows the set fan speed.	23	DEFROST LAMP (ORANGE)
	DISPLAY 'TEST' (INSPECTION/TEST OPERATION)	24	FAN/AIR CONDITIONING SELECTOR SWITCH
7	When the INSPECTION/TEST OPERATION BUTTON is pressed, the display shows the system mode is in.	25	COOL/HEAT CHANGEOVER SWITCH
	ON/OFF BUTTON		
8	Press the button and the system will start. Press the button again and the system will stop.		
	FAN SPEED CONTROL BUTTON		
9	Press this button to select the fan speed, HIGH or LOW, of your choice.		
	TEMPERATURE SETTING BUTTON		
10	Use this button for SETTING TEMPERATURE. (Operates with the front cover of the remote control closed.)		
	PROGRAMMING TIME BUTTON		
11	Use this button for programming "START and/or STOP" time. (Operates with the front cover of the remote control closed.)		
	TIMER MODE START/STOP BUTTON		

NOTES

- Please note that the display shows all indications for the purpose of explanation only. This is contrary to actual running situations.
- Figure 2 shows the remote control with the front cover opened.

8 BRC7E531W,530W - Infrared remote control

8 - 1 Dimensional drawing

(Unit: mm)

Remote control dimensions

Transmitting part

157

62

17.5

Remote control holder installation procedure
(Installation to wall surface)

Liquid crystal remote control (wireless)

Remote control holder

Receiver installation procedure

Drain piping side

Refrigerant piping side

Receiver

Decoration panel (BYFQ60BW1)

Receiver detail

BRC7E531W	Cooling only	FXZQ
BRC7E530W	Heat pump	

3D038937

9 BRC7E63W,66 - Infrared remote control

9 - 1 Dimensional drawing

(Unit: mm)

Remote control dimensions

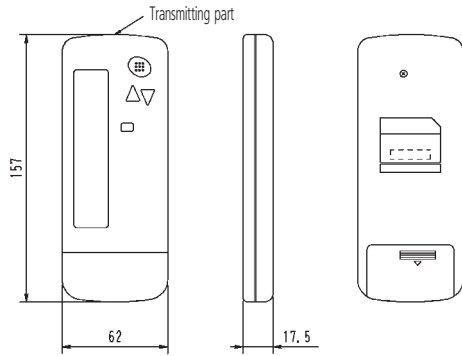

Receiver installation procedure

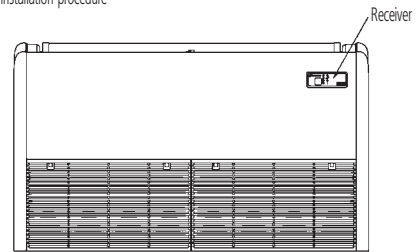

Remote control holder installation procedure (installation to wall surface)

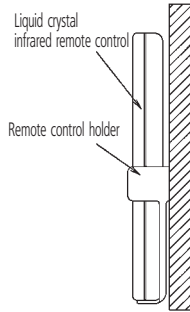

Receiver detail

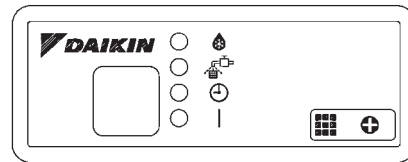

BRC7E63W	Heat pump	FXHQ
BRC7E66	Cooling only	

3D028963

9 BRC7E63W,66 - Infrared remote control

9 - 2 Explanation of buttons and functions

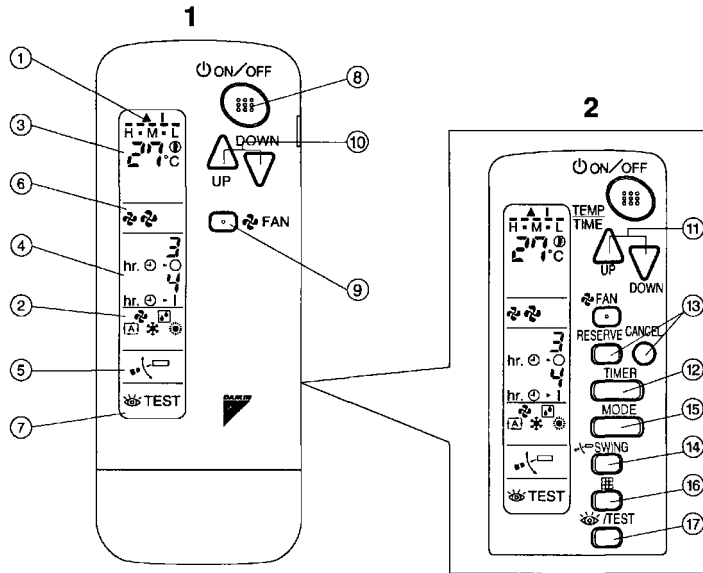

1	DISPLAY '7' (SIGNAL TRANSMISSION)	13	TIMER RESERVE/CANCEL BUTTON
	This lights up when a signal is being transmitted.	14	AIR FLOW DIRECTION ADJUST BUTTON
2	DISPLAY 'A', 'M', 'L', 'C', 'H', 'E', 'A', 'T', 'C', 'O', 'O', 'L', 'A', 'U', 'T', 'O', 'M', 'A', 'T', 'I', 'C', 'H', 'E', 'A', 'T', 'C', 'O', 'O', 'L', 'A', 'U', 'T', 'O', 'M', 'A', 'T', 'I', 'C' (OPERATION MODE)	15	OPERATION MODE SELECTOR BUTTON
	This display shows the current OPERATION MODE. For cooling only type, 'A' (Auto) and 'H' (Heating) are not installed.	16	FILTER SIGN RESET BUTTON
3	DISPLAY '27.0' (SET TEMPERATURE)	17	INSPECTION/TEST OPERATION BUTTON
	This display shows the set temperature.	18	EMERGENCY OPERATION SWITCH
4	DISPLAY '3hr', '5hr' (PROGRAMMED TIME)	19	RECEIVER
	This display shows PROGRAMMED TIME of the system start or stop.	20	OPERATING INDICATOR LAMP (RED)
5	DISPLAY 'A' (AIR FLOW FLAP)	21	TIMER INDICATOR LAMP (GREEN)
	DISPLAY '2', '3', '4' (FAN SPEED)	22	AIR FILTER CLEANING TIME INDICATOR LAMP (RED)
6	DISPLAY '2', '3', '4' (FAN SPEED)	23	DEFROST LAMP (ORANGE)
	The display shows the set fan speed.	24	FAN/AIR CONDITIONING SELECTOR SWITCH
7	DISPLAY 'TEST' (INSPECTION/TEST OPERATION)	25	COOL/HEAT CHANGEOVER SWITCH
	When the INSPECTION/TEST OPERATION BUTTON is pressed, the display shows the system mode is in.		Set the switch to "A" (FAN) for FAN and "C" (A/C) for HEAT or COOL.
8	ON/OFF BUTTON		Set the switch to "H" (COOL) for COOL and "L" (HEAT) for HEAT.
	Press the button and the system will start. Press the button again and the system will stop.		
9	FAN SPEED CONTROL BUTTON		
	Press this button to select the fan speed, HIGH or LOW, of your choice.		
10	TEMPERATURE SETTING BUTTON		
	Use this button for SETTING TEMPERATURE. (Operates with the front cover of the remote control closed.)		
11	PROGRAMMING TIME BUTTON		
	Use this button for programming "START and/or STOP" time. (Operates with the front cover of the remote control opened.)		
12	TIMER MODE START/STOP BUTTON		

NOTES

- Please note that the display shows all indications for the purpose of explanation only. This is contrary to actual running situations.
- Figure 2 shows the remote control with the front cover opened.

10 BRC7E618,619 - Infrared remote control

10 - 1 Dimensional drawing

10

(Unit: mm)

Remote control dimensions

Transmitting part

157

62

17.5

Receiver installation procedure

Receiver

Receiver detail

Remote controller holder installation procedure (Installation to wall surface)

Liquid crystal remote control (Wireless)





Remote controller holder

BRC7E618	Heat pump	FXAQ
BRC7E619	Cooling only	

3D034905

11 Survey of various control systems

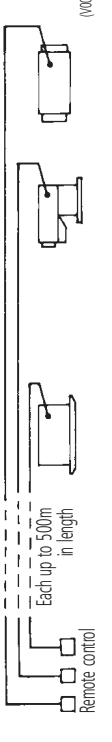
For more effective localized environmental control Daikin offers various control systems such as single or double remote control or centralized control. This enables the construction of a variety of operational control systems which can be adapted for various uses from remote control to building automation (BA).

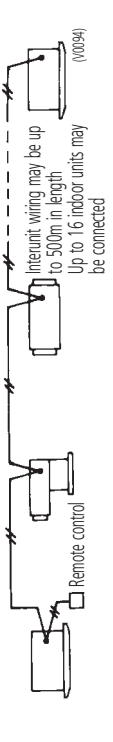
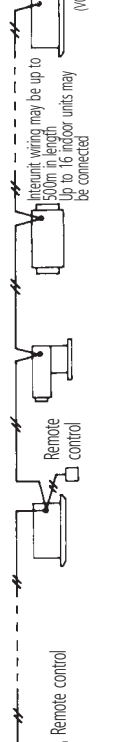
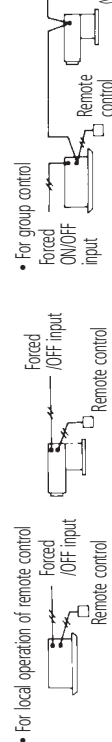
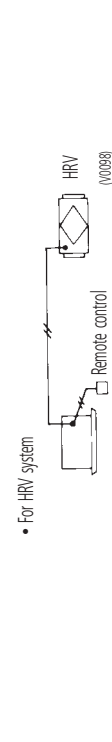
Control method	Objective / use	Unit name and model	Outline of system	Function	Standard number of units
Local operation of remote control	Remote operation of remote control	 BRC1C527		<ul style="list-style-type: none"> Operational functions <ul style="list-style-type: none"> -Start/Stop (ON/OFF) -Temperature setting -Timer setting (Settings in units of 1 hour up to a maximum of 72 hours) -Air flow setting -Air flow direction adjustment (Swing flap) BRC1A51 only Indication function <ul style="list-style-type: none"> -Operating display -Program dry function display -Defrost/Hot start display -Filter sign -Temperature setting display -Timer display -Air flow display -Abnormal operation display <p>★ In case of group control all the indoor units in the system are set to the same value and each unit is controlled individually by its internal thermostat. (Not by the thermostat equipped in remote control)</p> <p>In common case of double remote control the most recent takes priority. (Selection between master</p>	1 remote control controls 1 indoor unit
	For control from a distant place	 ★2 BRC2C51		<ul style="list-style-type: none"> Operating display -Program dry function display -Defrost/Hot start display -Filter sign -Temperature setting display -Timer display -Air flow display -Abnormal operation display <p>★ In case of group control all the indoor units in the system are set to the same value and each unit is controlled individually by its internal thermostat. (Not by the thermostat equipped in remote control)</p> <p>In common case of double remote control the most recent takes priority. (Selection between master</p>	2 remote controls control 1 indoor unit
2 remote controls	For control from 2 places (remote or local)			<ul style="list-style-type: none"> Operating display -Program dry function display -Defrost/Hot start display -Filter sign -Temperature setting display -Timer display -Air flow display -Abnormal operation display <p>★ In case of group control all the indoor units in the system are set to the same value and each unit is controlled individually by its internal thermostat. (Not by the thermostat equipped in remote control)</p> <p>In common case of double remote control the most recent takes priority. (Selection between master</p>	2 remote controls control 1 indoor unit
Group control (1)	Control of several indoor units on a floor at the same time			<ul style="list-style-type: none"> Operating display -Program dry function display -Defrost/Hot start display -Filter sign -Temperature setting display -Timer display -Air flow display -Abnormal operation display <p>★ In case of group control all the indoor units in the system are set to the same value and each unit is controlled individually by its internal thermostat. (Not by the thermostat equipped in remote control)</p> <p>In common case of double remote control the most recent takes priority. (Selection between master</p>	1 remote control controls up to 16 indoor units simultaneously
Group control by 2 remote controls (1)	For above control from distant place	Connected to indoor units		<ul style="list-style-type: none"> Operating display -Program dry function display -Defrost/Hot start display -Filter sign -Temperature setting display -Timer display -Air flow display -Abnormal operation display <p>★ In case of group control all the indoor units in the system are set to the same value and each unit is controlled individually by its internal thermostat. (Not by the thermostat equipped in remote control)</p> <p>In common case of double remote control the most recent takes priority. (Selection between master</p>	2 remote controls control up to 16 indoor units from 2 different places simultaneously
Forced OFF command from outside	If forgotten to turn equipment off, or in case of emergency	<ul style="list-style-type: none"> For group control it is connected to 1 unit out of the group In case of control by 2 remote controls both controls are connected to the indoor unit 		<ul style="list-style-type: none"> Operating display -Program dry function display -Defrost/Hot start display -Filter sign -Temperature setting display -Timer display -Air flow display -Abnormal operation display <p>★ In case of group control all the indoor units in the system are set to the same value and each unit is controlled individually by its internal thermostat. (Not by the thermostat equipped in remote control)</p> <p>In common case of double remote control the most recent takes priority. (Selection between master</p>	Same as the number of units controlled by remote control
Combining control by remote control	Operation of other equipment combined with the operation of indoor unit			<ul style="list-style-type: none"> Operating display -Program dry function display -Defrost/Hot start display -Filter sign -Temperature setting display -Timer display -Air flow display -Abnormal operation display <p>★ In case of group control all the indoor units in the system are set to the same value and each unit is controlled individually by its internal thermostat. (Not by the thermostat equipped in remote control)</p> <p>In common case of double remote control the most recent takes priority. (Selection between master</p>	Same as the number of units controlled by remote control

NOTES

- ★1 In case of group control, the remote control used as master control must be selected with auto-swing function (BRC1A51.61). When the group has cassette or ceiling suspended or cassette corner or wall mounted models.
- ★2 In case of using BRC2C51 (S-REMOCON) to heat recovery series, be sure not to use this independently. Use with other remote controls (BRC1A51.52, KRC19-26 or DCS302A51).

2

VRV III-S
VRV III
VRV VII



Daikin's unique position as a manufacturer of air conditioning equipment, compressors and refrigerants has led to its close involvement in environmental issues. For several years Daikin has had the intention to become a leader in the provision of products that have limited impact on the environment. This challenge demands the eco design and development of a wide range of products and an energy management system, resulting in energy conservation and a reduction of waste.



Daikin Europe N.V. is approved by LRQA for its Quality Management System in accordance with the ISO9001 standard. ISO9001 pertains to quality assurance regarding design, development, manufacturing as well as to services related to the product.



ISO14001 assures an effective environmental management system in order to help protect human health and the environment from the potential impact of our activities, products and services and to assist in maintaining and improving the quality of the environment.



Daikin units comply with the European regulations that guarantee the safety of the product.

The present publication is drawn up by way of information only and does not constitute an offer binding upon Daikin Europe N.V.. Daikin Europe N.V. has compiled the content of this publication to the best of its knowledge. No express or implied warranty is given for the completeness, accuracy, reliability or fitness for particular purpose of its content and the products and services presented therein. Specifications are subject to change without prior notice. Daikin Europe N.V. explicitly rejects any liability for any direct or indirect damage, in the broadest sense, arising from or related to the use and/or interpretation of this publication. All content is copyrighted by Daikin Europe N.V..

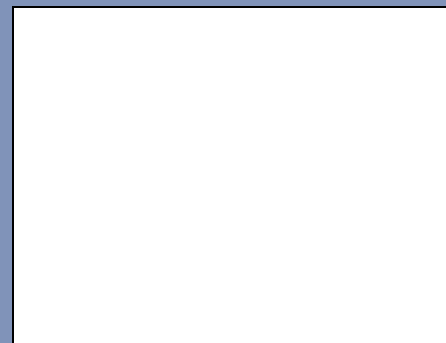

DAIKIN EUROPE N.V.

Naamloze Vennootschap
Zandvoordestraat 300
B-8400 Oostende, Belgium
www.daikin.eu
BTW: BE 0412 120 336
RPR Oostende

VRV products are not within the scope of the Eurovent certification programme.



EEDEN07-200 • 07/2007 • Copyright • Daikin
The present publication supersedes EED06-2.
Prepared in Belgium by Lannoo (www.lannooprint.be), a company whose concern for the environment is set in the EMAS and ISO 14001 systems.
Responsible Editor: Daikin Europe N.V., Zandvoordestraat 300, B-8400 Oostende