

VRV SYSTEM Inverter Air Conditioners

MODELS

Ceiling-mounted Duct type

FXMQ20PVE	FXMQ40PVE	FXMQ80PVE	FXMQ140PVE
FXMQ25PVE	FXMQ50PVE	FXMQ100PVE	
FXMQ32PVE	FXMQ63PVE	FXMQ125PVE	

READ THESE INSTRUCTIONS CAREFULLY BEFORE INSTALLATION.
KEEP THIS MANUAL IN A HANDY PLACE FOR FUTURE REFERENCE.

LESEN SIE DIESE ANWEISUNGEN VOR DER INSTALLATION SORGFÄLTIG DURCH.
BEWAHREN SIE DIESE ANLEITUNG FÜR SPÄTERE BEZUGNAHME GRIFFBEREIT AUF.

LIRE SOIGNEUSEMENT CES INSTRUCTIONS AVANT L'INSTALLATION.
CONSERVER CE MANUEL A PORTEE DE MAIN POUR REFERENCE ULTERIEURE.

LEA CUIDADOSAMENTE ESTAS INSTRUCCIONES ANTES DE INSTALAR.
GUARDE ESTE MANUAL EN UN LUGAR A MANO PARA LEER EN CASO DE TENER
ALGUNA DUDA.

PRIMA DELL'INSTALLAZIONE LEGGERE ATTENTAMENTE QUESTE ISTRUZIONI.
TENERE QUESTO MANUALE A PORTATA DI MANO PER RIFERIMENTI FUTURI.

ΔΙΑΒΑΣΤΕ ΠΡΟΣΕΚΤΙΚΑ ΑΥΤΕΣ ΤΙΣ ΟΔΗΓΙΕΣ ΠΡΙΝ ΑΠΟ ΤΗΝ ΕΓΚΑΤΑΣΤΑΣΗ ΕΧΕΤΕ ΑΥΤΟ
ΤΟ ΕΓΧΕΙΡΙΔΙΟ ΕΥΚΑΙΡΟ ΓΙΑ ΝΑ ΤΟ ΣΥΜΒΟΥΛΕΥΕΣΤΕ ΣΤΟ ΜΕΛΛΟΝ.

LEES DEZE INSTRUCTIES ZORGVULDIG DOOR VOOR INSTALLATIE. BEWAAR DEZE HAN-
DLEINDING WAAR U HEM KUNT TERUGVINDEN VOOR LATERE NASLAG.

LEIA COM ATENÇÃO ESTAS INSTRUÇÕES ANTES DE REALIZAR A INSTALAÇÃO.
MANTENHA ESTE MANUAL AO SEU ALCANCE PARA FUTURAS CONSULTAS.

ПЕРЕД НАЧАЛОМ МОНТАЖА ВНИМАТЕЛЬНО ОЗНАКОМЬТЕСЬ С ДАННЫМИ
ИНСТРУКЦИЯМИ. СОХРАНИТЕ ДАННОЕ РУКОВОДСТВО В МЕСТЕ, УДОБНОМ ДЛЯ
ОБРАЩЕНИЯ В БУДУЩЕМ.

安裝前務必仔細閱讀此安裝說明書，閱後妥善保存，以便隨時參看。

安裝前務必仔細閱讀此安裝說明書，閱後妥善保存，以便隨時參看。

English

Deutsch

Français

Español

Italiano

Ελληνικά

Nederlands

Portugues

Русский

中文
(繁體)中文
(簡體)

CE - DECLARATION-OF-CONFORMITY
 CE - KONFORMITÄTSSERKLÄRUNG
 CE - DECLARATION-DE CONFORMITE
 CE - CONFORMITÄTISVERKLARING

CE - DECLARACION-DE CONFORMIDAD
 CE - DICHIARAZIONE DI CONFORMITÀ
 CE - ΔΗΛΩΣΗ ΣΥΜΜΟΡΦΩΣΗΣ

CE - DECLARAÇÃO-DE CONFORMIDADE
 CE - ЗАЯВЛЕНИЕ О СООТВЕТСТВИИ
 CE - PROHLÁŠENÍ O SHODĚ

CE - ERKLÄRUNG OM-SAMSVAR
 CE - ILMOITUS-YHDENMUKAISUUDESTA
 CE - PROHLÁŠENÍ O SHODĚ

CE - IZJAVA O SKLADNOSTI
 CE - VASTAVLJENJE
 CE - ДЕКЛАРАЦИЯ-О СООТВЕТСТВИИ
 CE - ДЕКЛАРАЦИЈА-ОЗГОДНОСТИ
 CE - DECLARAȚIE-DE CONFORMITATE

CE - ATTIKTIKTES-DEKLARACIJA
 CE - ATBILSTĪBAS-DEKLARĀCIJA
 CE - VYHLÁŠENIE-ZHODY
 CE - UYUMLULUK-BİLDİRİSİ

DAIKIN INDUSTRIES, LTD.

01 (E) declares under its sole responsibility that the air conditioning models to which this declaration refers:
 02 (D) erklärt auf seine alleinige Verantwortung daß die Modelle der Klimaanlage für die diese Erklärung bestimmt ist:
 03 (F) déclare sous sa seule responsabilité que les appareils d'air conditionné visés par la présente déclaration:
 04 (NL) verklaart hierbij op eigen exclusieve verantwoordelijkheid dat de airconditioning units waarop deze verklaring betrekking heeft:
 05 (E) declara bajo su única responsabilidad que los modelos de aire acondicionado a los cuales hace referencia la declaración:
 06 (I) dichiara sotto sua responsabilità che i condizionatori modello a cui è riferita questa dichiarazione:
 07 (GR) δηλώνει με αποκλειστική της ευθύνη ότι το μοντέλο των κλιματιστικών συσκευών στα οποία αναφέρεται η παρούσα δήλωση:
 08 (P) declara sob sua exclusiva responsabilidade que os modelos de ar condicionado a que esta declaração se refere:
 09 (RU) заявляет исключительно под свою ответственность, что модели кондиционеров воздуха, к которым относится настоящее заявление:

FXMQ20PVE, FXMQ25PVE, FXMQ32PVE, FXMQ40PVE, FXMQ50PVE, FXMQ63PVE, FXMQ80PVE, FXMQ125PVE, FXMQ140PVE

10 (X) erklærer under enensvar, at klimaenligmodelerne, som denne deklaration vedrører:
 11 (S) deklarerar i egennskap av huvudsvarig, att luftkonditioneringsmodellerna som berörs av denna deklaration innebär att:
 12 (T) erklærer et fulstændigt ansvar for at de luftkonditioneringsmodeller som berøres af denne deklaration indebærer at:
 13 (HU) illoctaita yksimutalaan omaia vastuullaan, että tämän ilmoituksen tarkoitamat ilmastointilaitteen mallit:
 14 (CZ) prohlašuje ve své plné odpovědnosti, že modely klimatizace, k nimž se toto prohlášení vztahuje:
 15 (SK) zjavuje pod isključivo vlastitom odgovornosťou, že su modely klimatisačných zariadení, na ktoré sa ova zjáva odozva:
 16 (B) jeljes felelősséggel tudatában kijelenti, hogy a klímaberendezés modeljei, melyekre a nyilatkozati vonatkozás:
 17 (PL) deklaruje na własną i wyłączną odpowiedzialność, że modele klimatyzatorów, których dotyczy niniejsza deklaracja:
 18 (DE) erklärt per proprie răspundere că aparatele de aer condiționat la care se referă această declarație:

FXMQ20PVE, FXMQ25PVE, FXMQ32PVE, FXMQ40PVE, FXMQ50PVE, FXMQ63PVE, FXMQ80PVE, FXMQ125PVE, FXMQ140PVE

19 (S) z vsvo odgovornosti izjavlja, da so modeli klimatiskih naprav, na katere se izjava nanaša:
 20 (MT) kinnibab oña fidejkuq vassluqet, et kásewvna deklarazzjoni alla kulluvard klímaseadmette mudallit:
 21 (BG) декларира на своя отговорност, че моделите климатична инсталация, за които се отнася тази декларация:
 22 (LT) viską savo atsakomybę skelbia, kad oro kondicionavimo prietaisų modeliai, kuriems yra taikoma šis deklaracija:
 23 (LV) ir pilnu atbildību apliecinu, ka šādas uzskaitāmo modeļu gaisa kondicionātaji, uz kuriem attiecas šī deklarācija:
 24 (SK) vyhlasuje na vlastnú zodpovednosť, že tieto klimatizačné modely, na ktoré sa vzťahuje toto vyhlásenie:
 25 (HR) tamojane keni suomulluvijunda otnak zere bu dicitrimn ligni odliugu klima modelierimn asgudaki gubi odliugunu beyan eder:

FXMQ20PVE, FXMQ25PVE, FXMQ32PVE, FXMQ40PVE, FXMQ50PVE, FXMQ63PVE, FXMQ80PVE, FXMQ125PVE, FXMQ140PVE

01 are in conformity with the following standard(s) or other normative document(s), provided that these are used in accordance with our instructions:
 02 gemäß folgenden Norm(en) oder einem anderen Normdokument oder -dokumenten entspricht/entsprechen, unter der Voraussetzung, daß sie gemäß unseren Anweisungen eingesetzt werden:
 03 sont conformes à la(s) norme(s) ou autre(s) document(s) normatif(s), pour autant qu'ils soient utilisés conformément à nos instructions:
 04 conform de următoarele norme(n) de altă natură decât documentele tehnice, în condiția ca acestea să fie utilizate în conformitate cu instrucțiunile noastre:
 05 están en conformidad con la(s) siguiente(s) norma(s) u otro(s) documento(s) normativo(s), siempre que sean utilizados de acuerdo con nuestras instrucciones:
 06 sono conformi all(i) seguente(i) standard(i) o altro(i) documento(i) a carattere normativo, a patto che vengano usati in conformità alle nostre istruzioni:
 07 ziva súpoviedni z to(i) okolností(i) (prototyp(i) i ďalšie špecifické) konovojúv, untó tinv pruvodčoni ot' upovijuvovovuvra oduvovva je: t'ic odn'j'ec j'ac:
 08 (P) ziva súpoviedni z to(i) okolností(i) (prototyp(i) i ďalšie špecifické) konovojúv, untó tinv pruvodčoni ot' upovijuvovovuvra oduvovva je: t'ic odn'j'ec j'ac:

EN60335-2-40,

10 under the provisions of:
 01 gemäß den Vorschriften der:
 02 overeenkomstig de bepalingen van:
 03 siguiendo las disposiciones de:
 04 secondo le disposizioni per:
 05 de acordo com o previsto em:
 06 в соответствии с положениями:

16 Megjegyzés * a) /<A> alapján, a) /<A> igazolta a megjelölt, a) /<A> tanúsítvány szerint.
 17 Uwaga * zgodnie z dokumentacją <A> pozytywna opinia <A> świadectwem <A>
 18 Nota * este cum este stabilit în <A> și ar trebui pozitiv <A> în conformitate cu Certificatul <A>.
 19 Opomba * kak je izobrazeno v <A> in odobreno s strani <A> v skladu s ovrednotenjem <A>.
 20 Märkus * nagu on näidatud dokumentis <A> ja heaks kiidetud <A> järgi vastavalt sertifikaadile <A>.

01 Direktive, az amendei.
 02 Direktiven, gemäß Änderung.
 03 Directives, telles que modifiées.
 04 Richtlijnen, zoals gewijzigd.
 05 Directivas, según lo emendado.
 06 Directive, come da modifica.
 07 Döryüv, önyç şyvay' t'ropotovjei.
 08 Directivas, conforme alteração em.
 09 Директиве со всеми поправками.

11 Information * enligi <A> och godkännas <A> enligt Certifikat <A>.
 12 Merk * som framkommer <A> og gjennom positiv bedømmelse av <A> j'ølge Sertifikat <A>.
 13 Huom * j'olka on esitetty asiallisessa <A> ja j'olka <A> on j'atavoin Sertifikaatti <A> mukaisesti.
 14 Proszanka * jak bylo uwedano v <A> a pozitivnie zj'isleno <A> v skladu s ovrednotenim <A>.
 15 Napomena * kako je izobrazo u <A> i pozitivno ocijenjeno od strane <A> prema Certificatu <A>.

19 Direktive z vesmi spremembami.
 20 Direktivd koos muudatustega.
 21 Директивк, с техникте өзгөчөөнн.
 22 Direktivose su papildymais.
 23 Direktivās un to papildinājums.
 24 Smjernice, u skladu s izmjenama.
 25 Degiştirilmiş halleriyle Yönetmelikler.

<A>	DAIKIN.TCF.024D9/12-2008
	TÜV Rheinland EPS B.V.
<C>	0510260101



Shinri Sada

Shinri Sada
 Manager Quality Control Department
 9th of January 2009

DAIKIN INDUSTRIES, LTD.

Umeda Center Bldg., 2-4-12, Nakazaki-Nishi,
 Kita-ku, Osaka, 530-8323 Japan

CONTENTS

1. SAFETY PRECAUTIONS 1
 2. BEFORE INSTALLATION 2
 3. SELECTING INSTALLATION SITE 3
 4. PREPARATIONS BEFORE INSTALLATION..... 4
 5. INDOOR UNIT INSTALLATION 5
 6. REFRIGERANT PIPING WORK 5
 7. DRAIN PIPING WORK 7
 8. DUCT WORK 8
 9. ELECTRIC WIRING WORK 9
 10. WIRING EXAMPLE AND HOW TO SET
 THE REMOTE CONTROLLER..... 10
 11. FIELD SETTING..... 12
 12. TEST OPERATION..... 14

1. SAFETY PRECAUTIONS

Please read these “SAFETY PRECAUTIONS” carefully before installing air conditioning unit and be sure to install it correctly. After completing installation, conduct a trial operation to check for faults and explain to the customer how to operate the air conditioner and take care of it with the aid of the operation manual. Ask the customer to store the installation manual along with the operation manual for future reference.

This air conditioner comes under the term “appliances not accessible to the general public”.

Safety Precaution

This unit is a class A product. In a domestic environment this product may cause radio interference in which case the user may be required to take adequate measures.

Meaning of WARNING and CAUTION notices

 **WARNING** Failure to follow these instructions properly may result in personal injury or loss of life.

 **CAUTION** Failure to observe these instructions properly may result in property damage or personal injury, which may be serious depending on the circumstances.

 **WARNING**

- Ask your dealer or qualified personnel to carry out installation work.
Do not attempt to install the air conditioner yourself. Improper installation may result in water leakage, electric shocks or fire.
- Install the air conditioner in accordance with the instructions in this installation manual.
Improper installation may result in water leakage, electric shocks or fire.
- Consult your local dealer regarding what to do in case of refrigerant leakage. When the air conditioner is to be installed in a small room, it is necessary to take proper measures so that the amount of any leaked refrigerant does not exceed the concentration limit in the event of a leakage. Otherwise, this may lead to an accident due to oxygen depletion.

- Be sure to use only the specified accessories and parts for installation work.
Failure to use the specified parts may result in the unit falling, water leakage, electric shocks or fire.
- Install the air conditioner on a foundation strong enough to withstand the weight of the unit.
A foundation of insufficient strength may result in the equipment falling and causing injury.
- Carry out the specified installation work after taking into account strong winds, typhoons or earthquakes.
Failure to do so during installation work may result in the unit falling and causing accidents.
- Make sure that a separate power supply circuit is provided for this unit and that all electrical work is carried out by qualified personnel according to local laws and regulations and this installation manual.
An insufficient power supply capacity or improper electrical construction may lead to electric shocks or fire.
- Make sure that all wiring is secured, the specified wires are used, and that there is no strain on the terminal connections or wires.
Improper connections or securing of wires may result in abnormal heat build-up or fire.
- When wiring the power supply and connecting the remote controller wiring and transmission wiring, position the wires so that the control box lid can be securely fastened.
Improper positioning of the control box lid may result in electric shocks, fire or the terminals overheating.
- If refrigerant gas leaks during installation, ventilate the area immediately.
Toxic gas may be produced if the refrigerant comes into contact with fire.
- After completing installation, check for refrigerant gas leakage.
Toxic gas may be produced if the refrigerant gas leaks into the room and comes into contact with a source of fire, such as a fan heater, stove or cooker.
- Be sure to switch off the unit before touching any electrical parts.
- Be sure to earth the air conditioner.
Do not earth the unit to a utility pipe, lightning conductor or telephone earth lead. Imperfect earthing may result in electric shocks or fire.
A high surge current from lightning or other sources may cause damage to the air conditioner.
- Be sure to install an earth leakage breaker.
Failure to install an earth leakage breaker may result in electric shocks or fire.

 **CAUTION**

- While following the instructions in this installation manual, install drain piping to ensure proper drainage and insulate piping to prevent condensation.
Improper drain piping may result in indoor water leakage and property damage.
- Install the indoor and outdoor units, power cord and connecting wires at least 1 meter away from televisions or radios to prevent picture interference and noise.
(Depending on the incoming signal strength, a distance of 1 meter may not be sufficient to eliminate noise.)
- Remote controller (wireless kit) transmitting distance can be shorter than expected in rooms with electronic fluorescent lamps (inverter or rapid start types).
Install the indoor unit as far away from fluorescent lamps as possible.

- Do not install the air conditioner in the following locations:
 - Where there is a high concentration of mineral oil spray or vapour (e.g. a kitchen).
Plastic parts will deteriorate, parts may fall off and water leakage could result.
 - Where corrosive gas, such as sulphurous acid gas, is produced.
Corroding of copper pipes or soldered parts may result in refrigerant leakage.
 - Near machinery emitting electromagnetic radiation.
Electromagnetic radiation may disturb the operation of the control system and result in a malfunction of the unit.
 - Where flammable gas may leak, where there is carbon fibre or ignitable dust suspensions in the air, or where volatile flammables such as paint thinner or gasoline are handled.
Operating the unit in such conditions may result in fire.
- The air conditioner is not intended for use in a potentially explosive atmosphere.

2. BEFORE INSTALLATION

- When moving the unit while removing it from the carton box, be sure to lift it by holding on to the four lifting lugs without exerting any pressure on other parts, especially, the refrigerant piping, drain piping, flanges and other resin parts.
- Be sure to check the type of R410A refrigerant to be used before installing the unit. (Using an incorrect refrigerant will prevent normal operation of the unit.)
- The accessories needed for installation must be retained in your custody until the installation work is completed. Do not discard them!
- Decide upon a line of transport.
- Leave the unit inside its packaging while moving, until reaching the installation site. Where unpacking is unavoidable, use a sling of soft material or protective plates together with a rope when lifting, to avoid damage or scratches to the unit.
- When moving the unit or after opening, hold the unit by the hanger brackets (× 4). Do not apply force to the refrigerant piping, drain piping, flanges or plastic parts.
- For the installation of outdoor unit, refer to the installation manual attached to the outdoor unit.
- Do not install or operate the unit in rooms mentioned below.
 - Laden with mineral oil, or filled with oil vapor or spray like in kitchens. (Plastic parts may deteriorate which could eventually cause the unit to fall out of place, or could lead to leaks.)
 - Where corrosive gas like sulfurous gas exists. (Copper tubing and brazed spots may corrode which could eventually lead to refrigerant leaks.)
 - Where exposed to combustible gases and where volatile flammable gas like thinner or gasoline is used. (Gas in the vicinity of the unit could ignite.)
 - Where machines can generate electromagnetic waves. (Control system may malfunction.)
 - Where the air contains high levels of salt such as that near the ocean and where voltage fluctuates greatly such as that in factories.
Also in vehicles or vessels.
- This unit, both indoor and outdoor, is suitable for installation in a commercial and light industrial environment. If installed as a household appliance it could cause electromagnetic interference.

2-1 PRECAUTIONS

- Be sure to read this manual before installing the indoor unit.
- Entrust installation to the place of purchase or a qualified serviceman. Improper installation could lead to leaks and, in worse cases, electric shock of fire.
- Use only parts provided with the unit or parts satisfying required specifications. Unspecified parts could cause the unit to fall out of place, or could lead to leaks and, in worse cases, electric shock or fire.
- Be sure to mount an air filter (part to be procured in the field) in the suction air passage in order to prevent water leaking, etc.

2-2 ACCESSORIES

Check that the following accessories are provided and that each accessory is correct in amount.
Refer to the Fig. 1 of this sheet.

[PRECAUTION]

The accessories are required for the installation of the air conditioner. Be sure to keep them until the installation work is completed.

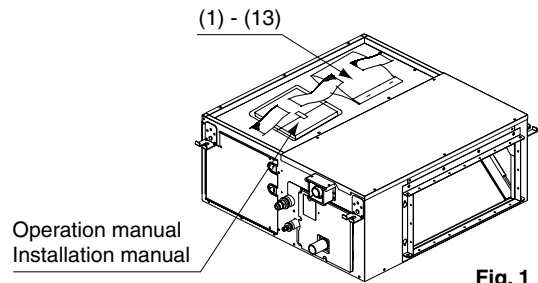





Fig. 1

Name	Metal clamp (1)	Drain hose (2)	Screws for duct flanges (3)	Insulation for fitting								
Quantity	1 pc.	1 pc.	As described in table below	1 each								
Shape			M5×16 <table border="1"> <tr> <td>20 • 25 • 32 type</td> <td>6</td> </tr> <tr> <td>40 type</td> <td>10</td> </tr> <tr> <td>50 • 63 • 80 type</td> <td>18</td> </tr> <tr> <td>100 • 125 • 140 type</td> <td>26</td> </tr> </table>	20 • 25 • 32 type	6	40 type	10	50 • 63 • 80 type	18	100 • 125 • 140 type	26	Thin for liquid pipe (4) Thick for gas pipe (5)
20 • 25 • 32 type	6											
40 type	10											
50 • 63 • 80 type	18											
100 • 125 • 140 type	26											

Name	Sealing pad	Clamp (8)	Washer fixing plate (9)	Wire sealing material (10)
Quantity	—	9 pcs.	4 pcs.	2 pcs.
Shape	 1 pc. Large (Dark gray) (6) 2 pcs. Middle (Dark gray) (7)			 Small (Gray)

Name	Washer (11)	Wire fixing bracket (12)	Wire fixing screw (13)	(Other)
Quantity	8 pcs.	2 pcs.	2 pcs.	• Operation manual • Installation manual
Shape			M4×8 	

2-3 OPTIONAL ACCESSORIES

- These are two types of remote controllers: wired and wireless. Select a remote controller according to customer request and install in an appropriate place.

Table 1

Remote controller	
Wired type	
Wireless type	Heat pump type
	Cooling only type

NOTE

- If you wish to use a remote controller that is not listed in Table 1, select a suitable remote controller after consulting catalogs and technical materials.

FOR THE FOLLOWING ITEMS, TAKE SPECIAL CARE DURING CONSTRUCTION AND CHECK AFTER INSTALLATION IS FINISHED.

a. Items to be checked after completion of work

Items to be checked	If not properly done, what is likely to occur.	Check
Are the indoor and outdoor unit fixed firmly?	The units may drop, vibrate or make noise.	
Was the installation of the outdoor unit completed?	The unit may malfunction or the components burn out.	
Is the gas leak test finished?	No cooling or heating.	
Is the unit fully insulated? (Refrigerant piping, drain piping, and duct)	Condensate water may drip.	
Does drainage flow smoothly?	Condensate water may drip.	
Does the power supply voltage conform to the indication on the name plate?	The unit may malfunction or the components burn out.	
Are wiring and piping correct?	The unit may malfunction or the components burn out.	
Is the air conditioner properly grounded?	Dangerous in case of current leakage.	
Is wiring size according to specifications?	The unit may malfunction or the components burn out.	
Is something blocking the air outlet or inlet of either the indoor or outdoor units?	No cooling or heating.	
Did you set the external static pressure?	No cooling or heating.	
Are refrigerant piping length and additional refrigerant charge noted down?	The refrigerant charge in the system is not clear.	
Did you check that no wiring connection screws were loose?	Electric shock or fire.	

Also review the "SAFETY PRECAUTIONS".

b. Items to be checked at time of delivery

Items to be checked	Check
Are you sure the control box lid, air filter, air inlet grille, and air outlet grille are mounted?	
Did you explain about operations while showing the operation manual to your customer?	
Did you deliver the operation manual along with the installation manual to the customer?	
Did you explain the customer the handling and cleaning methods of the field supplies (e.g., the air filter, air inlet grilles, and air outlet grille)?	
Did you deliver instruction manual, if any, for the field supplies to the customer?	

c. Points for explanation about operations

The items with \triangle WARNING and \triangle CAUTION marks in the operation manual are the items pertaining to possibilities for bodily injury and material damage in addition to the general usage of the product. Accordingly, it is necessary that you make a full explanation about the described contents and also ask your customers to read the operation manual.

2-4 NOTE TO INSTALLER

- Be sure to instruct customers how to properly operate the unit (especially cleaning filters, operating different functions, and adjusting the temperature) by having them carry out operations themselves while looking at the manual.

3. SELECTING INSTALLATION SITE

<Hold the hanging brackets in the case of moving the indoor and outdoor units at the time of and after opening the packages. Do not impose undue force on other parts, such as the refrigerant piping, drain piping, or flanges, in particular.>

<Add heat insulation material to the indoor unit if the temperature above the ceiling is likely to exceed 30°C and a relative humidity of 80%.>

<Make sure that the insulation material is made of glass wool or polyethylene foam, has a minimum thickness of 10 mm, and can be accommodated in the opening on the ceiling.>

- (1) Select an installation site where the following conditions are fulfilled and that meets with your customer's approval.
 - A place where cool (warm) air is delivered to the entire room.
 - Where nothing blocks the air passage.
 - Where condensate can be properly drained.
 - If supporting structural members are not strong enough to take the unit's weight, the unit could fall out of place and cause serious injury.
 - Where the false ceiling is not noticeably on an incline.
 - Where there is no risk of flammable gas leakage.
 - Where sufficient clearance for maintenance and service can be ensured. **(Refer to Fig. 2-1)**
 - Where piping between indoor and outdoor units is possible within the allowable limit. (Refer to the installation manual of the outdoor unit.)

CAUTION

- Install the indoor and outdoor units, power supply wiring and connecting wires at least 1 meter away from televisions or radios in order to prevent image interference or noise. (Depending on the radio waves, a distance of 1 meter may not be sufficient enough to eliminate the noise.)

- In the case of the installation of a wireless remote controller, the transmission distance of the wireless remote controller may be shortened if the room has a fluorescent light of electronic lighting type (i.e., an inverter or rapid-start fluorescent light). Keep the distance between the receiver and the fluorescent light as far as possible.

- Use hanging bolts to install the indoor unit. Check that the place of installation withstands the weight of the indoor unit. Secure the hanging bolts with proper beams if necessary.

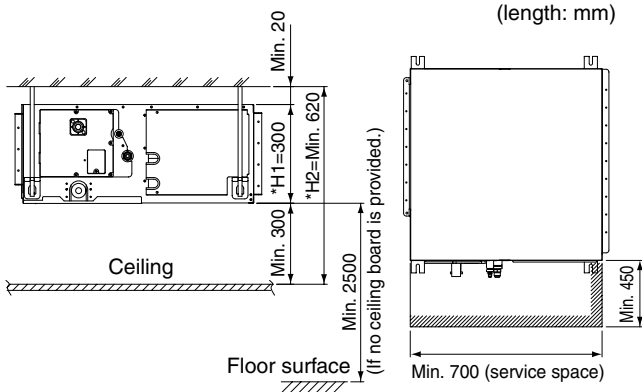

- The H1 dimension indicates the height of the product.
 - Determine the H2 dimension by maintaining a downward slope of at least 1/100 as specified in "7. DRAIN PIPING WORK".
- [Required installation place]
The dimensions indicate the minimum required space of installation.

Fig. 2-1

4. PREPARATIONS BEFORE INSTALLATION

- Check the positional relationship between the ceiling opening hole and the hanging bolt of the unit.
 - For the maintenance, inspection, and other servicing purposes of the control box and drain pump, prepare one of the following service spaces.
 - Inspection hatch 1 (450 × 450) for the control box and a minimum space of 300 mm for the lower part of the product. (Refer to Fig. 2-2)
 - Inspection hatch 1 (450 × 450) for the control box and inspection hatch 2 for the lower part of the product (see axial direction view A-1). (Refer to Fig. 2-3)
 - Inspection hatch 3 for the lower part of the product and the lower part of the control box (see axial direction view A-2). (Refer to Fig. 2-3)

Case 1

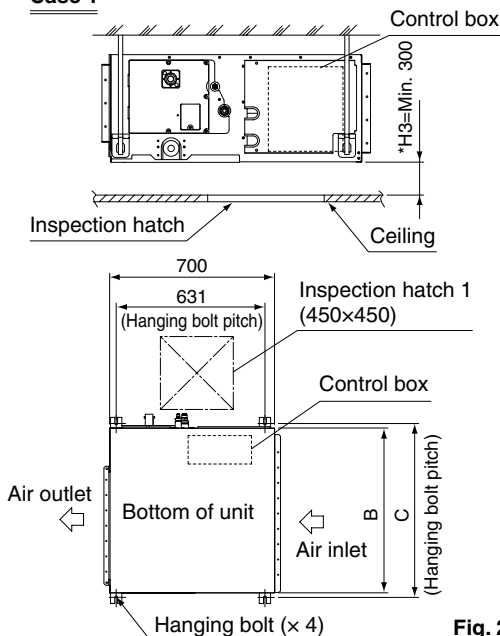
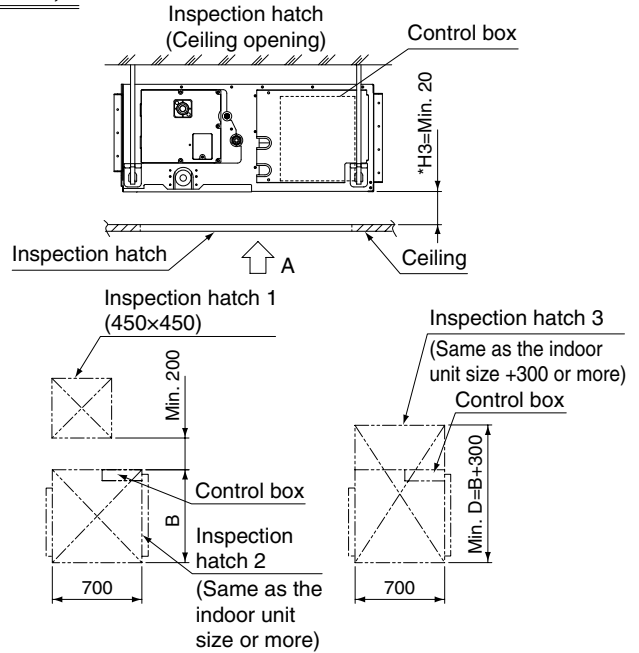

Fig. 2-2

Case 2, 3



Axial direction view A-1

Axial direction view A-2

Fig. 2-3

Model	B	C	D
20 • 25 • 32 type	550	583	850
40 type	700	738	1000
50 • 63 • 80 type	1000	1038	1300
100 • 125 • 140 type	1400	1438	1700

(length: mm)

- Determine the H3 dimension by maintaining a downward slope of at least 1/100 as specified in "7. DRAIN PIPING WORK".

- Mount the canvas ducts to the air outlet and inlet so that the vibration of the air conditioner will not be transmitted to the duct or ceiling. Apply a sound-absorbing material (insulation material) to the inner wall of the duct and vibration insulation rubber to the hanging bolts (refer to 8. DUCT WORK).
- Open installation holes (if the ceiling already exists).
 - Open the installation holes on the ceiling. Lay the refrigerant piping, drain piping, power line, transmission wiring, and remote controller wiring for the piping and wiring connection port of the unit.

In the case of the installation of a wireless remote controller, refer to the installation manual provided with the wireless remote controller.

Refer to 6. REFRIGERANT PIPING WORK, 7. DRAIN PIPING WORK, and 10. WIRING EXAMPLE AND HOW TO SET THE REMOTE CONTROLLER.

 - The ceiling framework may need reinforcement in order to keep the ceiling horizontal and prevent the vibration of the ceiling after the installation holes are opened. For details, consult your construction or interior contractor.

- Install the hanging bolts. Make sure that the hanging bolts are M10 in size.
 - Use hole-in anchors if the hanging bolts already exist; otherwise use embedded inserts and embedded foundation bolts so that they will withstand the weight of the unit. Adjust the distance to the ceiling surface in advance.

< Installation example >

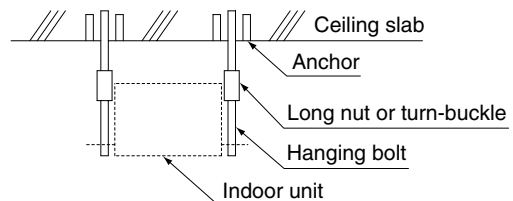

Note) All the above parts are field supplied.

5. INDOOR UNIT INSTALLATION

⟨It may be easier to install accessories (sold separately) before installing the indoor unit. Refer to the installation manuals provided to the accessories as well.⟩

Be sure to use the accessories and specified parts for installation work.

- (1) Temporarily install the indoor unit.
 - Connect the hanging brackets to the hanging bolts. Be sure to use and tighten the nut and washer (11) for each hanging bracket on both upper and lower sides of the hanging bracket. (Refer to Fig. 3) At that time, the fall of the washer (11) for the hanging bracket can be prevented if the washer fixing plate (9) is used.

[Fixing hanging brackets]

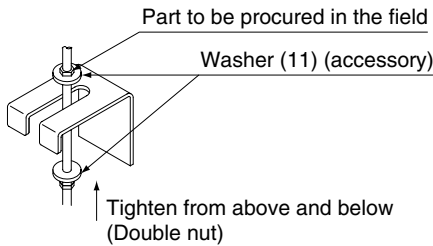

[Fixing method of washers]

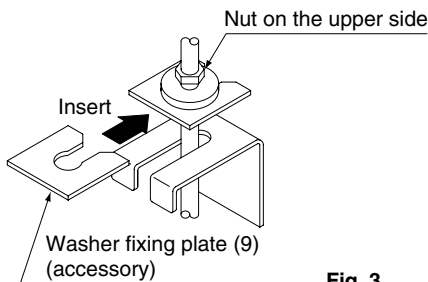
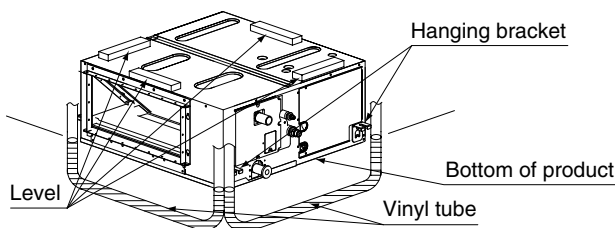

Fig. 3

CAUTION

- During the installation work, perform the curing of the air outlet and protect the resin drain pan of the indoor unit from the intrusion of foreign substances, such as welding spatters. Otherwise, water leakage may occur as a result of damage, such as hole damage, to the resin drain pan.

- (2) Make adjustments so that the unit will be in the right position.
- (3) Check the level of the unit.
- (4) Remove the washer fixing plates for the falling prevention of the washers for the hanging brackets, tighten the nuts on the upper side, and securely fix the unit.



CAUTION

- Use the level and check that the unit is installed horizontally. (4-directions)
- In the case of using a vinyl tube in place of the level, put the both edges of the vinyl tube in close contact with the bottom of the product to make levelness adjustment. If the unit is installed at a slant with the drain pipe side set high, in particular, the float switch will not operate normally and water leakage may result.

6. REFRIGERANT PIPING WORK

⟨As for the refrigerant piping of the outdoor unit, refer to the installation manual provided to the outdoor unit.⟩

⟨Perform heat insulation work on both gas piping and liquid piping, or otherwise water leakage may result.⟩

⟨Use the insulation material that withstands a temperature of 120°C.⟩

⟨Reinforce the insulation material for the refrigerant piping if the ambient temperature is high, or otherwise dew condensation may result on the surface of the insulation material.⟩

⟨Make sure that the refrigerant is R410A before refrigerant piping work. If the refrigerant is different, the air conditioner will not operate normally.⟩

CAUTION

This product uses new refrigerant (R410A) only. Be sure to keep the items on the right-hand side and conduct the installation work.

- Use a dedicated pipe cutter and flare tool for R410A.
- When connecting the flare, apply ether oil or ester oil only to inner side of the flare.
- Be sure to use the flare nut provided with the unit. (Do not use a different flare nut (such as a type-1 flare nut), or otherwise refrigerant leakage may result.)
- Perform the curing of the piping with pinching or taping of the piping in order to prevent the intrusion of dirt, dust, and moisture into the piping.

CAUTION

- Be sure to use the specified type of refrigerant for the refrigeration cycle and do not contaminate the refrigerant with air.
- Ventilate the room in case of refrigerant leakage during installation work.

- (1) Connect the piping.

- The outdoor unit is filled with refrigerant.
- When connecting or disconnecting piping to or from the unit, **be sure to use two spanners and two torque wrenches.** (Refer to Fig. 4)

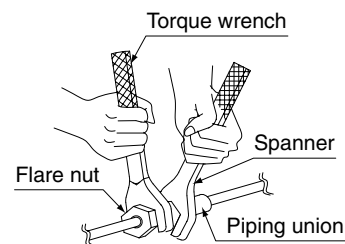

Fig. 4

- Refer to Table 2 for the processing dimensions of the flare.
- Use the flare nut provided with the unit.
- **Apply ether oil or ester oil only to inner side of the flare** and screw in the flare nut three to four turns first by hand at the time of connecting the flare nut. (Refer to Fig. 5)

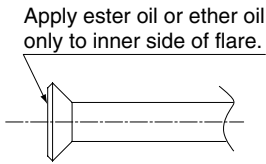

Fig. 5

- Refer to Table 2 for the corresponding tightening torque.

Table 2

Pipe size	Tightening torque	Flare dimensions A (mm)	Flare shape
φ 6.4	14.2 – 17.2N·m	8.7 – 9.1	
φ 9.5	32.7 – 39.9N·m	12.8 – 13.2	
φ 12.7	49.5 – 60.3N·m	16.2 – 16.6	
φ 15.9	61.8 – 75.4N·m	19.3 – 19.7	

CAUTION

- **Do not excessively tighten the flare nut.**
Doing so will break the flare nut and refrigerant leakage may result.
- **Make sure that all parts around the flare are free of oil.**
The drain pan and the resin part may be deteriorated if oil is attached.

- If no torque wrenches are available, refer to Table 3 as a standard.
When the flare nut is tightened with the spanner, the tightening torque should increase suddenly. Tighten the flare nut further for the corresponding angle shown in Table 3.

Table 3

Pipe size	Further tightening angle	Recommended arm length of tool
φ 6.4	60 to 90 degrees	Approx. 150mm
φ 9.5	60 to 90 degrees	Approx. 200mm
φ 12.7	30 to 60 degrees	Approx. 250mm
φ 15.9	30 to 60 degrees	Approx. 300mm

- (2) On completion of installation work, **check that there is no gas leakage.**

- (3) Refer to the illustration on the right-hand side and be sure to perform heat insulation work on the piping joints after gas leakage checks. (Refer to Fig. 6)

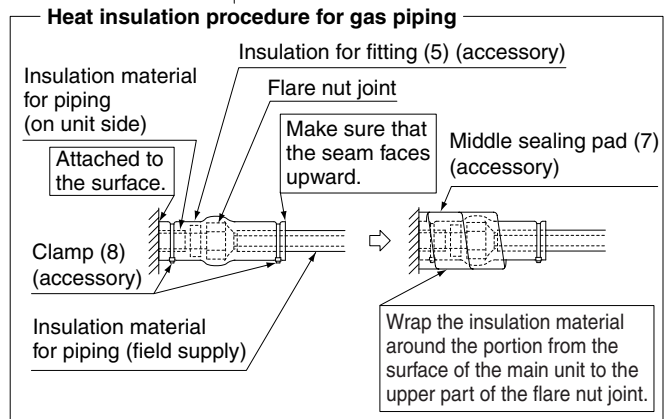
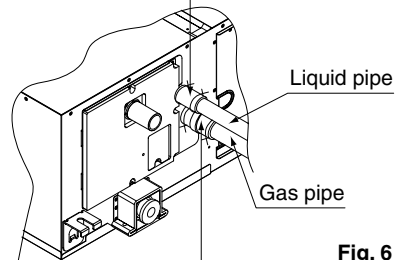
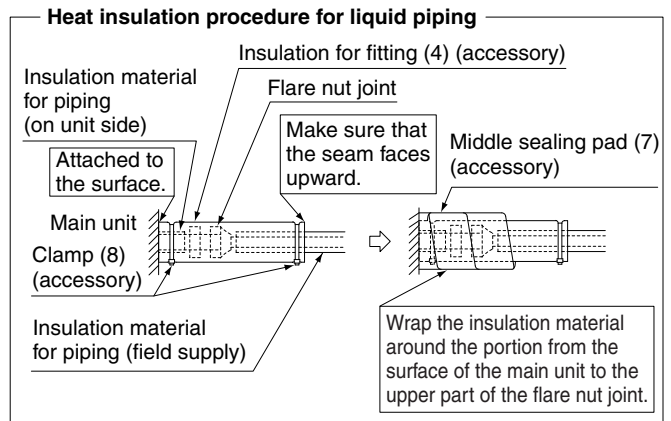

- Use the insulation for fitting (4) and (5) provided to the liquid piping and gas piping, respectively, and conduct heat insulation work. (Tighten both edges of the insulation for fitting (4) and (5) for each joint with the clamp (8).)
- Make sure that the joint of the insulation for fitting (4) and (5) for the joint on the liquid piping and gas piping side faces upward.
- Wrap the middle sealing material (7) around the insulation for fitting (4) and (5) for the joint (flare nut part).

CAUTION

- **Be sure to perform the heat insulation of the local piping up to the piping joint.**
If the piping is exposed, dew condensation may result. Furthermore, a burn may be caused if a human body comes in contact with the piping.

- Perform nitrogen substituent or apply nitrogen into the refrigerant piping (see NOTE 1) in the case of refrigerant piping brazing (see NOTE 2). Then perform the flare connection of the indoor unit. (Refer to Fig. 7)

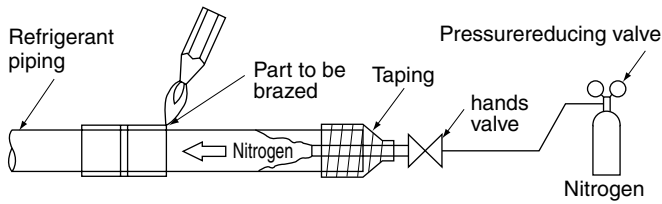

Fig. 7

CAUTION

- Do not use any antioxidant at the time of piping brazing. The piping may be clogged with a residual antioxidant and parts may malfunction.

NOTE

1. At the time of brazing, set the pressure of nitrogen to approximately 0.02 MPa (close to the pressure of a breeze coming in contact with the cheek) with a decompression valve.
 2. Do not use flux at the time of brazing and connecting the refrigerant piping. Use a copper phosphorus brazing alloy (BCuP-2: JIS Z 3264/BCu 93P-710/795: ISO3677), which does not require flux, for brazing. (Flux has a bad influence on the refrigerant piping. Chlorine-based flux will cause piping corrosion. Furthermore, if it contains fluorine, the flux will deteriorate refrigerant oil.)
- As for the branching of the refrigerant piping or refrigerant, refer to the installation manual provided with the outdoor unit.

7. DRAIN PIPING WORK

(1) Conduct drain piping work.

Check that the piping ensures proper draining.

- Make sure that the diameter of the piping excluding the rising part is the same as or larger than the diameter of the connecting pipe (vinyl chloride pipe with an outer diameter of 32 mm and a nominal inner diameter of 25 mm).
- Make sure that the piping is short enough **with a downward slope of at least 1/100** and that there is no air bank formed. No drain trap is required.

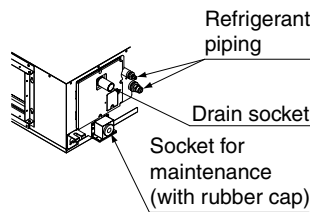

CAUTION

- The drain piping will be clogged with water and water leakage may result if the water is accumulated in the drain piping.
- Conduct drain-up piping work if the gradient is insufficient.
- Attach a support bracket at 1 to 1.5 m intervals for the prevention of piping deflection.

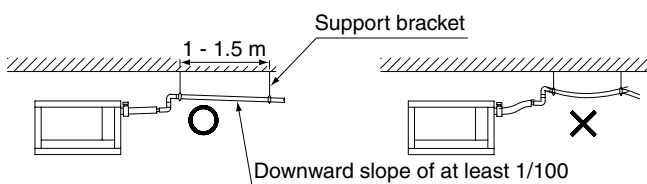

- Be sure to use the drain hose (2) and metal clamp (1). **Insert the drain hose (2) deep into the base of the drain socket, and securely fasten the metal clamp (1) within the taped part on the insertion front end of the hose.**

Be sure to fasten the screw of the metal clamp (1) until the margin of the screw thread decreases to 4 mm or less.

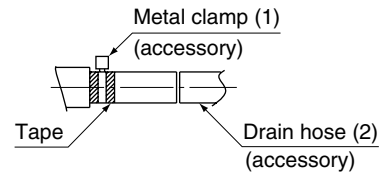

NOTE

Be sure to follow the instructions as below.

- Do not connect the drain piping directly to a sewer that smells of ammonia. The ammonia in the sewer may reach through the drain piping and corrode the heat exchanger of the indoor unit.
- Do not bend or twist the provided drain hose (2) in order not to impose excessive force on the hose. (Doing so may result in water leakage.)
- Take the procedure shown in the following illustration to perform concentrated drain piping.

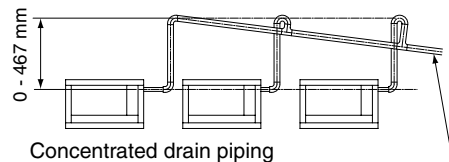

Maintain a downward slope of at least 1/100 so that no air bank will be formed.

The drain piping will be clogged with water and water leakage may result if the water is accumulated in the drain piping.

- Select the diameter of the concentrated drain piping to suit the capacity of equipment connecting to the concentrated drain piping (see the equipment design sheet).

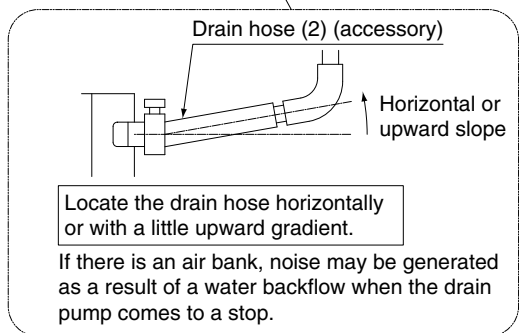
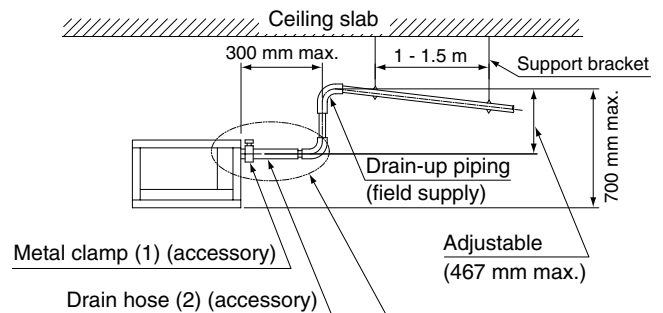

Locate the drain hose horizontally or with a little upward gradient.

If there is an air bank, noise may be generated as a result of a water backflow when the drain pump comes to a stop.

- (2) Check the smooth draining of the piping on completion of the installation of the piping.

[Before electrical work]

⚠ CAUTION

- A licensed electrical engineering technician must conduct electrical wiring work (including grounding work).
- If no licensed electrical engineering technician is available, take steps 3 and 4 after the test operation of the air conditioner is finished.

1. Remove the control box lid, and connect the single-phase electric wires to terminals L and N of the terminal block and the ground wire to the ground terminal. Perform wiring according to 10-1 CONNECTING POWER SUPPLY, GROUND, REMOTE CONTROLLER, AND TRANSMISSION WIRING in 10. WIRING EXAMPLE AND HOW TO SET THE REMOTE CONTROLLER.

⚠ CAUTION

- In order not to impose tension on the wire connections, perform clamping securely with the provided clamp (8) specified in 3 in 10-1 CONNECTING POWER SUPPLY, GROUND, REMOTE CONTROLLER, AND TRANSMISSION WIRING.

2. Check that the control box lid is closed before turning the air conditioner ON.
3. Provide **approximately one liter of water** gradually into the drain pan through the water inlet on the bottom of the drain socket or the outlet. Make sure that the water is not spilled onto the drain pump.
4. The drain pump will operate with the power turned ON. Check that the pump drains water smoothly. (The drain pump will stop automatically in 10 minutes.) The drainage can be checked with the water level change in the drain pan through the water inlet.

⚠ CAUTION

- **Do not touch the drain pump.** Otherwise, an electric shock may be received.
- **Do not impose external force on the float switch.** Otherwise, a failure may result.

5. On completion of the drainage check, shut off the power supply and disconnect the power supply line.
6. Put the control box lid to the original position.

[After electrical work]

- After completion of 8. DUCT WORK provide **approximately one liter of water** gradually into the drain pan through the water inlet on the bottom of the drain socket, and check that the water is drained while the air conditioner is in cooling operation according to 11. FIELD SETTING and 12. TEST OPERATION. Make sure that the water is not spilled onto the electric parts of the drain pump and others.

- (3) **Be sure to conduct heat insulation work on the following portions, or otherwise water leakage may occur as a result of dew condensation.**

- Drain piping indoors
- Drain socket

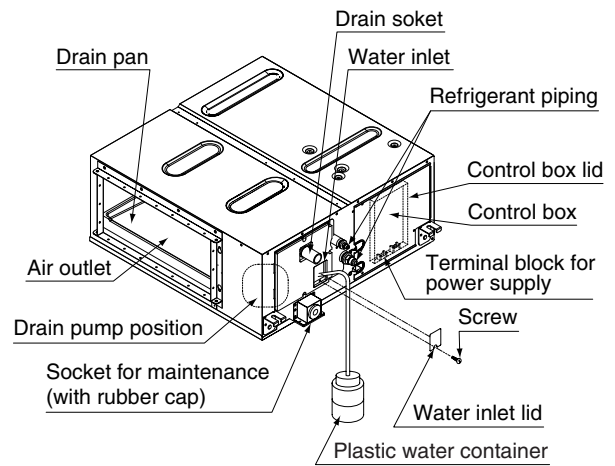

- On completion of the drainage check, refer to the following illustration, and use the provided large sealing pad (6) and heat insulate the metal clamp (1) and drain hose (2).

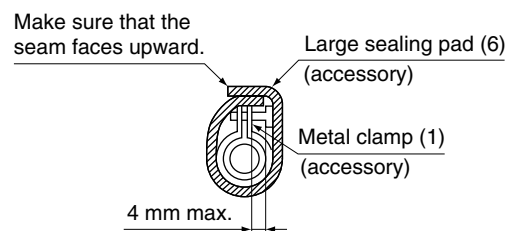

8. DUCT WORK

Pay the utmost attention to the following items and conduct the ductwork.

- Check that the duct will not be in excess of the setting range of external static pressure for the unit. (Refer to the technical datasheet for the setting range. Each model has each setting range of external static pressure.)
- Attach a canvas duct each to the air outlet and air inlet so that the vibration of the equipment will not be transmitted to the duct or ceiling. Use a sound-absorbing material (insulation material) for the lining of the duct and apply vibration insulation rubber to the hanging bolts.
- At the time of duct welding, perform the curing of the duct so that the sputter will not come in contact with the drain pan for the filter.
- If the metal duct pass through a metal lath, wire lath, or metal plate of a wooden structure, separate the duct and wall electrically.
- Be sure to heat insulate the duct for the prevention of dew condensation. (Material: Glass wool or styrene foam; Thickness: 25 mm)
- Be sure to attach the field supply air filter to the air inlet of the unit or field supply inlet in the air passage on the air suction side. (Be sure to select an air filter with a duct collection efficiency of 50 weight percent.)
- Explain the operation and washing methods of the locally procured components (i.e., the air filter, air inlet grille, and air outlet grille) to the customer.
- Locate the air outlet grille on the indoor side for the prevention of drafts in a position where indirect contact with people.
- The air conditioner incorporates a function to adjust the fan to rated speed automatically. (11. FIELD SETTING) Therefore, do not use booster fans midway in the duct.

Connection method of ducts on air inlet and outlet sides.

- Connect the field supply duct in alignment with the inner side of the flange.
- Connect the flange and unit with the flange connection screw (3).
- Wrap aluminum tape around the flange and duct joint in order to prevent air leakage.

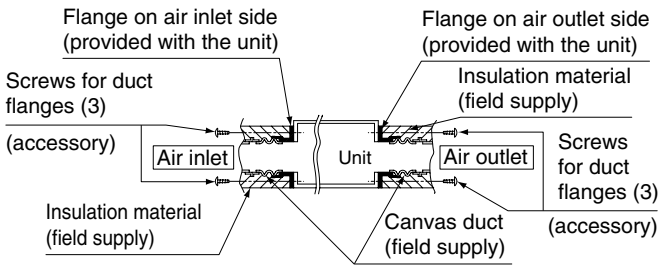

CAUTION
 Connect the flange and unit with the flange connection screw (3) regardless of whether the duct is connected to the air inlet side.

9. ELECTRIC WIRING WORK

9-1 GENERAL INSTRUCTIONS

- All field supplied parts and materials and electric works must conform to local codes.
- Use copper wire only.
- For electric wiring work, refer to also “Wiring diagram” attached to the control box lid.
- For remote controller wiring details, refer to the installation manual attached to the remote controller.
- All wiring must be performed by an authorized electrician.
- This system consists of multiple indoor units. Mark each indoor unit as unit A, unit B..., and be sure the terminal board wiring to the outdoor unit and BS unit are properly matched. If wiring and piping between the outdoor unit and an indoor unit are mismatched, the system may cause a malfunction.
- A circuit breaker capable of shutting down power supply to the entire system must be installed.
- Refer to the installation manual attached to the outdoor unit for the size of power supply wiring connected to the outdoor unit, the capacity of the circuit breaker and switch, and wiring instructions.
- Be sure to ground the air conditioner.
- Do not connect the ground wire to gas and water pipes, lightning rods, or telephone ground wires.
 - Gas pipes : might cause explosions or fire if gas leaks.
 - Water pipes : no grounding effect if hard vinyl piping is used.
 - Telephone ground wires or lightning rods : might cause abnormally high electric potential in the ground during lightning storms.

9-2 ELECTRICAL CHARACTERISTICS

Model	Units			Power supply		Fan motor	
	Hz	Volts	Voltage range	MCA	MFA	kW	FLA
FXMQ20PVE	50	220-240	Max. 264 Min. 198	0.6	16	0.09	0.5
FXMQ25PVE				0.6	16	0.09	0.5
FXMQ32PVE				0.6	16	0.09	0.5
FXMQ40PVE				1.4	16	0.140	1.1
FXMQ50PVE				1.6	16	0.350	1.3
FXMQ63PVE				1.8	16	0.350	1.4
FXMQ80PVE				2.3	16	0.350	1.8
FXMQ100PVE				2.9	16	0.350	2.3
FXMQ125PVE				3.4	16	0.350	2.7
FXMQ140PVE				3.4	16	0.350	2.7
FXMQ20PVE	60	220	Max. 242 Min. 198	0.6	16	0.09	0.5
FXMQ25PVE				0.6	16	0.09	0.5
FXMQ32PVE				0.6	16	0.09	0.5
FXMQ40PVE				1.4	16	0.140	1.1
FXMQ50PVE				1.6	16	0.350	1.3
FXMQ63PVE				1.8	16	0.350	1.4
FXMQ80PVE				2.3	16	0.350	1.8
FXMQ100PVE				2.9	16	0.350	2.3
FXMQ125PVE				3.4	16	0.350	2.7
FXMQ140PVE				3.4	16	0.350	2.7

MCA: Min. Circuit Amps (A); MFA: Max. Fuse Amps (A)
 kW: Fan Motor Rated Output (kW); FLA: Full Load Amps (A)

9-3 SPECIFICATIONS FOR FIELD SUPPLIED FUSES AND WIRE

Model	Power supply wiring			Remote controller wiring Transmission wiring	
	Field fuses 	Wire	Size	Wire	Size
FXMQ20PVE	16A	H05VV-U3G	Size must comply with local codes.	Sheathed wire (2 wire)	0.75 - 1.25 mm ²
FXMQ25PVE					
FXMQ32PVE					
FXMQ40PVE					
FXMQ50PVE					
FXMQ63PVE					
FXMQ80PVE					
FXMQ100PVE					
FXMQ125PVE					
FXMQ140PVE					

Allowable length of transmission wirings and remote controller wiring are as follows.

- (1) Outdoor unit – Indoor unit:
 Max. 1000 m (Total wiring length: 2000 m)
- (2) Indoor unit – Remote controller:
 Max. 500 m

NOTE 

1. Shows only in case of protected pipes. Use H07RN-F in case of no protection.
2. Vinyl cord with sheath or cable (Insulated thickness : 1mm or more)

10. WIRING EXAMPLE AND HOW TO SET THE REMOTE CONTROLLER

10-1 CONNECTING POWER SUPPLY, GROUND, REMOTE CONTROLLER, AND TRANSMISSION WIRING

(Remove the control box lid as shown below and connect each wire.)

- (1) Remove the control box lid.

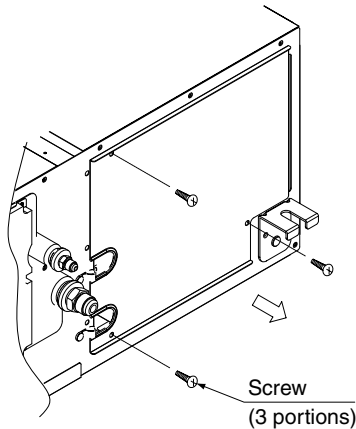

- (2) Lay the wires in the control box through the wire inlet on the side of the control box.

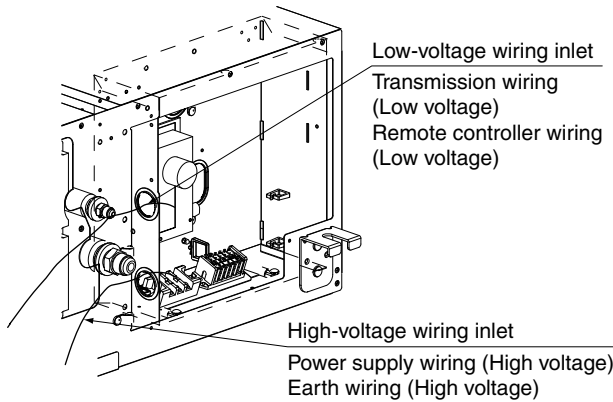

CAUTION 

- Do not lay the remote controller wiring or transmission wiring along with the power supply wiring or other electric wiring in the same route. Separate the remote controller wiring and transmission wiring at least 50 mm from the power supply wiring or other electric wiring, or otherwise malfunctions or failures may be caused by external electric noise that may interfere with the remote controller wiring and transmission wiring.
- For the installation and wiring of the remote controller, refer to the remote controller installation manual provided with the remote controller.
- For power supply wiring, refer to the wiring diagram as well.
- Be sure to connect the remote controller wiring and transmission wiring correctly to the right terminal block.

- (3) Follow the instructions below, and lay the wires in the control box.

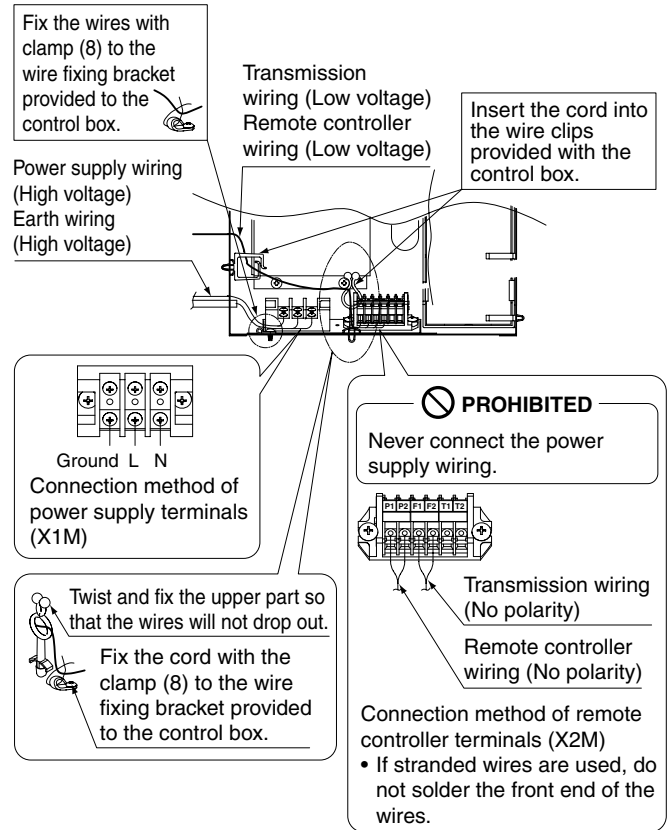

WARNING 

Trim and lay the wiring neatly and attach the control box lid securely.

An electric shock or fire may result if the control box lid catches any wiring or the wires push up the lid.

- (4) Put the control box lid, and wrap the wire sealing material (Small) (10) around the wires so as to block the wire through holes.

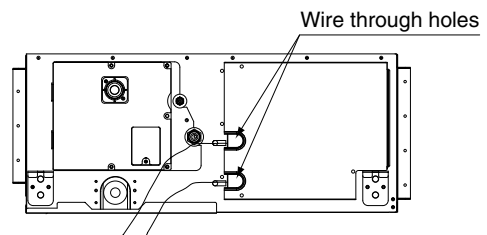

CAUTION 

- After all the wiring connections are done, fill in any gaps in the through holes with putty or insulation (procured locally) to prevent small animals and insects from entering the unit from outside. (If any do get in, they could cause short circuits in the control box.)

- (5) Mount the provided wire fixing bracket (12) with the wire fixing screw (13). Fix each wire with the provided clamp (8).

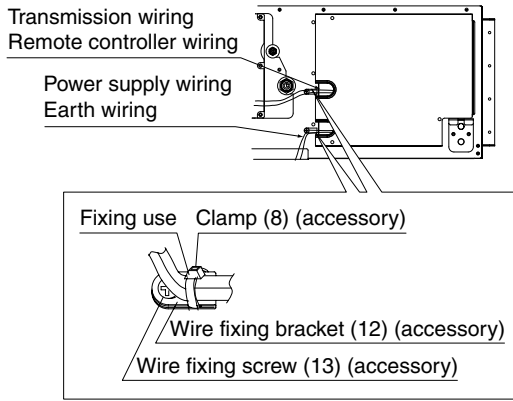

[Precautions for Power Supply Wiring]

- Connect round crimp-style terminals provided with insulation sleeves to the terminal block for power supply.

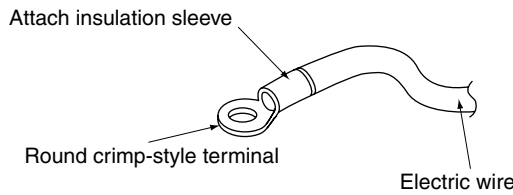

Be sure to follow the instructions provided below if the specified terminals cannot be used.

Otherwise, abnormal heat may be generated as a result of the loosening of the wires.

- Connect the wires evenly.
- Do not connect a wire to the single side only.
- Do not connect wires different from each other in diameter.

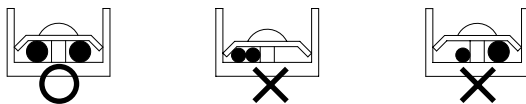

- If stranded wires are used, do not solder the front end of the wires.
- Connect proper wires securely and fix the wires so that external force will not be imposed on the terminals.
- Use an appropriate screwdriver to tighten the terminal screws. The screw heads may be damaged if the screwdriver is too small and the terminal screws will not be tightened properly.
- Do not tighten the terminal screws excessively, or otherwise the screw heads may be damaged.
- Refer to the table below for the required tightening torque values of the terminal screws.

	Tightening torque (N·m)
Terminal block for remote controller and transmission wires	0.80 - 0.96
Terminal block for power supply	1.18 - 1.44

10-2 WIRING EXAMPLE

— ⚠ WARNING —

Install an earth leakage breaker.

The installation of an earth leakage breaker is imperative for the prevention of electric shocks and fire accidents.

No. 1 system: When using 1 remote controller for 1 indoor unit

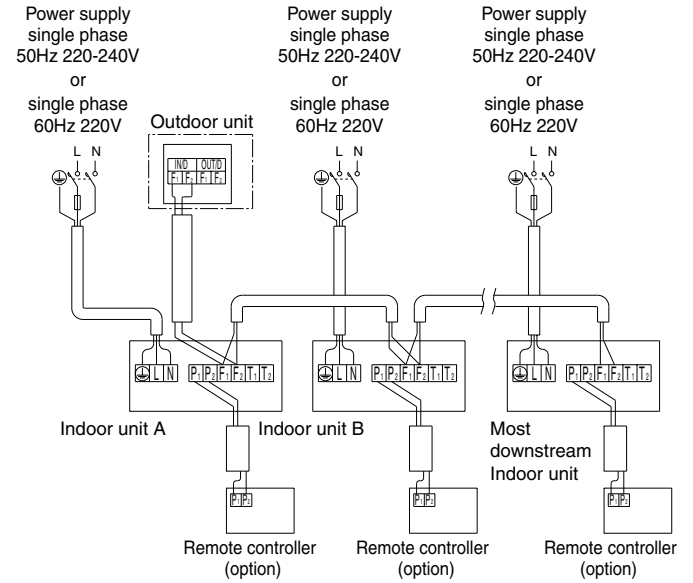

No. 2 system: For group control or use with 2 remote controllers

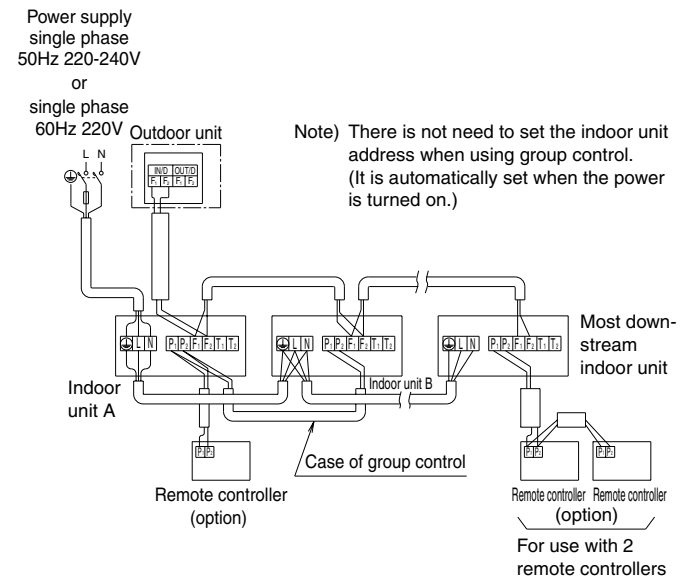

No. 3 system: When including BS unit

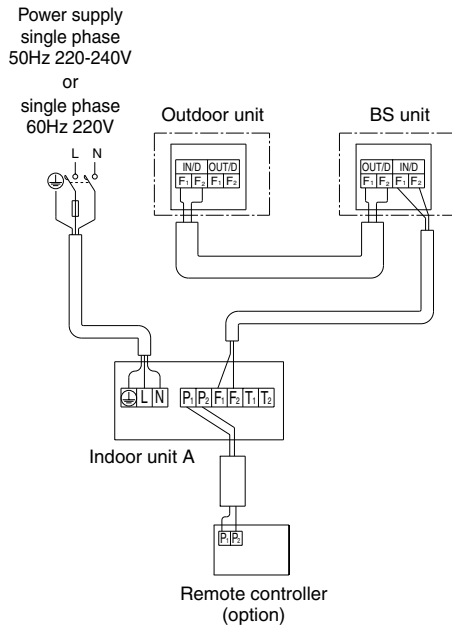

[PRECAUTIONS]

1. If no earth leakage breaker is required, install a breaker or load switch with a fuse for the wiring. If an earth leakage breaker is required, make sure that the earth leakage breaker is designed to protect the air conditioner from ground faults, overloads, and short-circuiting.
2. The remote controller wiring (P1 and P2) and transmission wiring (F1 and F2) have no polarity.

10-3 CONTROL BY 2 REMOTE CONTROLLERS (Controlling 1 indoor unit by 2 remote controllers)

- Set one of the remote controllers to main and the other to sub in the case of remote control with two remote controllers.

Switching Main/Sub

- (1) Insert a ⊖ screwdriver into the clearance between the grooves of the lower casing and the upper casing to remove the upper casing. (2 grooves) (The remote controller PCB is attached to the upper casing.)

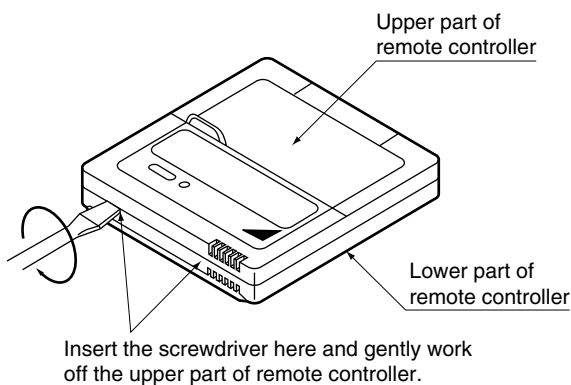

- (2) Set the main/sub switch on one of the remote controller PCBs to sub. (Keep the switch of the other remote controller PCB set to main.)

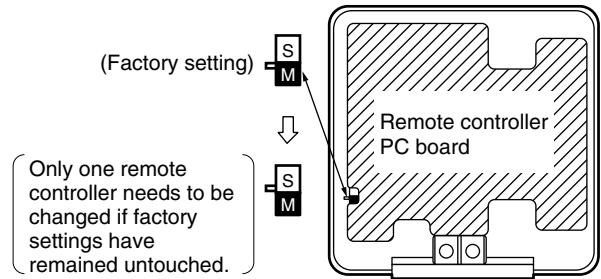

10-4 COMPUTERISED CONTROL (FORCED OFF AND ON/OFF OPERATION)

- (1) Wire specifications and how to perform wiring
 - Connect the input from outside to terminals T1 and T2 of the terminal block for remote controller.

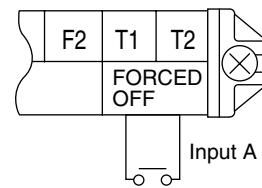

Wire specification	Sheathed vinyl cord or cable (2 wire)
Gauge	0.75 - 1.25 mm ²
Length	Max. 100 m
External terminal	Contact that can ensure the minimum applicable load of 15 V DC, 10 mA.

- (2) Actuation
 - The following table explains FORCED OFF and ON/OFF OPERATIONS in response to Input A.

FORCED OFF	ON/OFF OPERATION
Input "ON" stops operation (impossible by remote controllers.)	Input OFF → ON turns ON unit.
Input OFF enables control by remote controller.	Input ON → OFF turns OFF unit.

- (3) How to select FORCED OFF and ON/OFF OPERATION
 - Turn the power on and then use the remote controller to select operation.

10-5 CENTRALIZED CONTROL

- For centralized control, it is necessary to designate the group No. For details, refer to the manual of each optional controllers for centralized control.

11. FIELD SETTING

NOTE

- Before the test operation of the outdoor unit as explained in **12. TEST OPERATION**, be sure to make the following field settings as explained in **11. FIELD SETTING**.

Make sure the control box lids are closed on the indoor and outdoor units.

Field setting must be made from the remote controller in accordance with the installation condition.

- Setting can be made by changing the "MODE NO.", "FIRST CODE NO.", and "SECOND CODE NO."

- For setting and operation, refer to the “FIELD SETTING” in the installation manual of the remote controller.

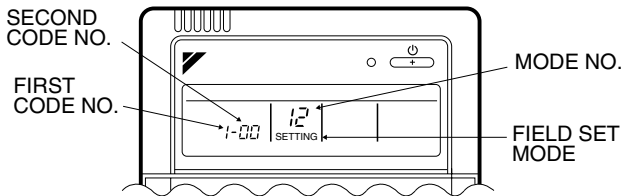

- Set the remote controller to the “FIELD SET MODE”. For details, refer to the “HOW TO SET IN THE FIELD”, in the remote controller manual.
- When in the “FIELD SET MODE”, select “MODE NO. 12”, then set the “FIRST CODE NO.” to “1”. Then set “SECOND CODE NO.” to “01” for FORCED OFF and “02” for ON/OFF OPERATION. (FORCED OFF at factory set)

With Wireless Remote Controller Used

Set the wireless remote controller address before using the wireless remote controller.

For the setting method of the address, refer to the operation manual provided with the wireless remote controller.

NOTE

- A “MODE NO.” is set on a group basis. To make a mode setting on a room unit basis or check the setting made, however, set the corresponding mode number in the parentheses.

1. Settings for Optional Accessories

- In the case of connecting optional accessories, refer to the operation manuals provided with the optional accessories and make necessary settings.

2. External Static Pressure Settings

Make settings in either method (a) or method (b) as explained below. (FXMQ140PVE cannot be selected method (a). Please select method (b).)

(a) Use the airflow auto adjustment function to make settings.

Airflow auto adjustment: The volume of blow-off air is automatically adjusted to the rated quantity.

- Check that power supply wiring to the air conditioner is completed along with duct installation. If a closing damper is installed in the air-conditioning system, make sure that the closing damper is opened. Furthermore, check that the air filter as a field supply is attached to the air passage on the suction side.
- If there are a number of air outlets and inlets, adjust the throttles so that the airflow rate of each air outlet and inlet will coincide with the designed airflow rate. At that time, operate the air conditioner in “fan operation mode”. To change the airflow rate, press and set the airflow adjustment button of the remote controller to HH, H, or L.
- Make settings for airflow automatic adjustment. After setting the air conditioner to “fan operation mode”, stop the air conditioner, go to “FIELD SET MODE”, select “MODE NO. 21” (11 in the case of group settings), set the setting “FIRST CODE NO.” to 7, and set the setting “SECOND CODE NO.” to 03.

Return to normal mode after these settings, and press the ON/OFF OPERATION button. Then the operation lamp will be lit and the air conditioner will go into fan operation for airflow automatic adjustment. Do not adjust the throttles of the air outlets or inlets during automatic adjustment of the air conditioner. After the air conditioner runs approximately one to eight minutes, the air conditioner will finish airflow adjustment automatically, the operation lamp will be turned OFF, and the air conditioner will come to a stop.

Table 4

MODE NO.	FIRST CODE NO.	Setting contents
11 (21)	7	Airflow adjustment
SECOND CODE NO.		
01	02	03
OFF	Completion of airflow adjustment	Start of airflow adjustment

- After the air conditioner stops operating, check with “MODE NO. 21” on an indoor unit basis that 02 is set for the “SECOND CODE NO.” in Table 4. If the air conditioner does not stop operating automatically or the “SECOND CODE NO.” is not 02, repeat steps from (3). If the outdoor unit is not turned ON, U4 or UH as explained in Table 8 will be displayed. This display is not problematic, because this function is set for the indoor unit. Continue setting the function. After setting this function, be sure to turn ON the outdoor unit before the test operation of the outdoor unit. If any other error is displayed, refer to Table 8 and the operation manual provided with the outdoor unit and check the defective point.

CAUTION

- If there is any change after airflow adjustment in the ventilation paths (e.g., the duct and air outlet), be sure to make airflow auto adjustment again.
- Consult your Daikin representative if there is any change in the ventilation paths (e.g., the duct and air outlet) after the test operation of the outdoor unit is finished or the air conditioner is moved to another place.

(b) Select External Static Pressure with Remote Controller Check that 01 (OFF) is set for the “SECOND CODE NO.” in “MODE NO. 21” for airflow adjustment on an indoor unit basis in Table 4. The “SECOND CODE NO.” is set to 01 (OFF) at factory set. Change the “SECOND CODE NO.” as shown in Table 5 according to the external static pressure of the duct to be connected.

- The “SECOND CODE NO.” is set to 07 (an external static pressure of 100 Pa) at factory set. (FXMQ40 · 50 · 63 · 80 · 100 · 125 · 140PVE)
The “SECOND CODE NO.” is set to 02 (an external static pressure of 50 Pa) at factory set. (FXMQ20 · 25 · 32PVE)
*1 The FXMQ50 · 63 · 80 · 100 · 125PVE cannot be set to 30 Pa.
*2 The FXMQ40PVE cannot be set to 180 or 200 Pa.
*3 The FXMQ20 · 25 · 32PVE cannot be set to 110-200 Pa.
*4 The FXMQ140PVE cannot be set to 30 Pa and 150-200 Pa.

Table 5

External Static Pressure	MODE NO.	FIRST CODE NO.	SECOND CODE NO.
30Pa (*1)(*4)	13 (23)	06	01
50Pa			02
60Pa			03
70Pa			04
80Pa			05
90Pa			06
100Pa			07
110Pa (*3)			08
120Pa (*3)			09
130Pa (*3)			10
140Pa (*3)			11
150Pa (*3)(*4)			12
160Pa (*3)(*4)			13
180Pa (*2)(*3)(*4)			14
200Pa (*2)(*3)(*4)			15

CAUTION

Keep in mind that a shortage of airflow quantity or water leakage will result because the air conditioner will be operated outside the rated range of airflow quantity if the external static pressure is wrongly set.

3. Filter Sign Settings

- The remote controller is provided with an LCD that tells the time of air filter cleaning.
- If the air conditioner is used in places with excessive dust, change the "SECOND CODE NO." as shown in Table 6. The "SECOND CODE NO." is set to 01 (standard) at factory set.

Table 6

Dirt	Time for display	MODE NO.	FIRST CODE NO.	SECOND CODE NO.
Standard	Approximately 2500 hours	10 (20)	0	01
Excessive dust	Approximately 1250 hours			02
No display (*)			3	

* Select "No display" under conditions in which the cleaning display is not required, such as the time of regular maintenance.

12. TEST OPERATION

Refer to the installation manual of the outdoor unit.

- The operation lamp of the remote controller will flash when an malfunction occurs. Check the malfunction code on the liquid crystal display to identify the point of trouble. An explanation of malfunction codes and the corresponding trouble is provided in "CAUTION FOR SERVICING" of the outdoor unit. If any of the items in Table 8 are displayed, there may be a problem with the wiring or power, so check the wiring again.

Table 7

Remote controller display	Contents
"A8" lit	Error in power supply voltage to indoor unit.
"C1" lit	Fan driver PCB of indoor unit ↔ indoor control PCB transmission error.
"C6" lit	Improper combination of fan driver PCB of indoor unit or setting failure in control PCB type.
"U3" lit	Test operation of outdoor unit has not been finished.

Table 8

Remote control display	Content
"  is lit up	<ul style="list-style-type: none"> There is a short circuit at the FORCED OFF terminals (T1, T2)
"U4" is lit up "UH" is lit up	<ul style="list-style-type: none"> The power on the outdoor unit is off. The outdoor unit has not been wired for power supply. Incorrect wiring for the transmission wiring and / or FORCED OFF wiring.
No display	<ul style="list-style-type: none"> The power on the indoor unit is off. The indoor unit has not been wired for power supply. Incorrect wiring for the remote controller wiring, the transmission wiring and / or the FORCED OFF wiring.

CAUTION

If interior finish work is continuing on completion of the test operation of the air conditioner, explain the customer not to operate the air conditioner until the interior finish work is completed for the protection of the air conditioner. Otherwise, substances that will be generated from interior finish work materials, such as paint and adhesive agents, may contaminate the air conditioner.

