

DAIKIN

INVERTER

DAIKIN ROOM AIR CONDITIONER

Operation Manual

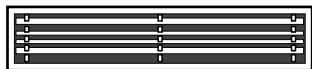

MODELS	FDXS25CVMB	FDKS25CVMB
	FDXS35CVMB	FDKS35CVMB
	CDXS50CVMB	CDKS50CVMB
	CDXS60CVMB	CDKS60CVMB



English

Deutsch

Français

Nederlands

Español

Italiano

Ελληνικά

Portugues

Русский

CONTENTS

READ BEFORE OPERATION

Safety precautions	2
Names of parts	4
Preparation Before Operation	7

OPERATION

AUTO · DRY · COOL · HEAT · FAN Operation	10
POWERFUL Operation	12
OUTDOOR UNIT SILENT Operation	13
HOME LEAVE Operation	14
TIMER Operation	16
Note for Multi System	18

CARE

Care and Cleaning	20
-------------------------	----

TROUBLE SHOOTING

Trouble Shooting	22
------------------------	----

Safety precautions

- Keep this manual where the operator can easily find them.
- Read this manual attentively before starting up the unit.
- For safety reason the operator must read the following cautions carefully.
- This manual classifies precautions into WARNING and CAUTION. Be sure to follow all precautions below: they are all important for ensuring safety.

WARNING

If you do not follow these instructions exactly, the unit may cause property damage, personal injury or loss of life.

CAUTION

If you do not follow these instructions exactly, the unit may cause minor or moderate property damage or personal injury.



Never do.



Be sure to earth the air conditioner.



Never touch the air conditioner (including the remote controller) with a wet hand.



Be sure to follow the instructions.



Never cause the air conditioner (including the remote controller) to get wet.





WARNING

- In order to avoid fire, explosion or injury, do not operate the unit when harmful, among which flammable or corrosive gases, are detected near the unit. 
- It is not good for health to expose your body to the air flow for a long time.
- Do not put a finger, a rod or other objects into the air outlet or inlet. As the fan is rotating at a high speed, it will cause injury.
- Do not attempt to repair, relocate, modify or reinstall the air conditioner by yourself. Incorrect work will cause electric shocks, fire etc. For repairs and reinstallation, consult your Daikin dealer for advice and information.

- The refrigerant used in the air conditioner is safe. Although leaks should not occur, if for some reason any refrigerant happens to leak into the room, make sure it does not come in contact with any flame as of gas heaters, kerosene heaters or gas range. 
- If the air conditioner is not cooling (heating) properly, the refrigerant may be leaking, so call your dealer. When carrying out repairs accompanying adding refrigerant, check the content of the repairs with our service staff.
- Do not attempt to install the air conditioner by your self. Incorrect work will result in water leakage, electric shocks or fire. For installation, consult the dealer or a qualified technician.
- In order to avoid electric shock, fire or injury, if you detect any abnormally such as smell of fire, stop the operation and turn off the breaker. And call your dealer for instructions.





CAUTION

- The air conditioner must be earthed. Incomplete earthing may result in electric shocks. Do not connect the earth line to a gas pipe, water pipe, lightning rod, or a telephone earth line. 
- In order to avoid any quality deterioration, do not use the unit for cooling precision instruments, food, plants, animals or works of art. 
- Never expose little children, plants or animals directly to the air flow.
- Do not place appliances which produce open fire in places exposed to the air flow from the unit or under the indoor unit. It may cause incomplete combustion or deformation of the unit due to the heat.
- Do not block air inlets nor outlets. Impaired air flow may result in insufficient performance or trouble.

- Do not stand or sit on the outdoor unit. Do not place any object on the unit to avoid injury, do not remove the fan guard.
- Do not place anything under the indoor or outdoor unit that must be kept away from moisture. In certain conditions, moisture in the air may condense and drip.
- After a long use, check the unit stand and fittings for damage.
- Do not touch the air inlet and aluminum fins of outdoor unit. It may cause injury.
- The appliance is not intended for use by young children or infirm persons without supervision.
- Young children should be supervised to ensure that they do not play with the appliance.

-
- To avoid oxygen deficiency, ventilate the room sufficiently if equipment with burner is used together with the air conditioner. 
 - Before cleaning, be sure to stop the operation, turn the breaker off or pull out the supply cord.
 - Do not connect the air conditioner to a power supply different from the one as specified. It may cause trouble or fire.
 - Depending on the environment, an earth leakage breaker must be installed. Lack of an earth leakage breaker may result in electric shocks.
 - Arrange the drain hose to ensure smooth drainage. Incomplete draining may cause wetting of the building, furniture etc.
 - Do not place things that must be kept dry under the indoor unit water may drip from the indoor unit if the humidity is 80% or above or when the drain outlet is clogged or the air-filter is dirtied.

-
- Do not operate the air conditioner with wet hands. 

-
- Do not wash the indoor unit with excessive water, only use a slightly wet cloth.
 - Do not place things such as vessels containing water or anything else on top of the unit. Water may penetrate into the unit and degrade electrical insulations, resulting in an electric shock. 

Installation site.

- To install the air conditioner in the following types of environments, consult the dealer.
 - Places with an oily ambient or where steam or soot occurs.
 - Salty environment such as coastal areas.
 - Places where sulfide gas occurs such as hot springs.
 - Places where snow may block the outdoor unit.

The drain from the outdoor unit must be discharged to a place of good drainage.

Consider nuisance to your neighbours from noises.

- For installation, choose a place as described below.
 - A place solid enough to bear the weight of the unit which does not amplify the operation noise or vibration.
 - A place from where the air discharged from the outdoor unit or the operation noise will not annoy your neighbours.

Electrical work.

- For power supply, be sure to use a separate power circuit dedicated to the air conditioner.

System relocation.

- Relocating the air conditioner requires specialized knowledge and skills. Please consult the dealer if relocation is necessary for moving or remodeling.

Names of parts

■ Indoor Unit

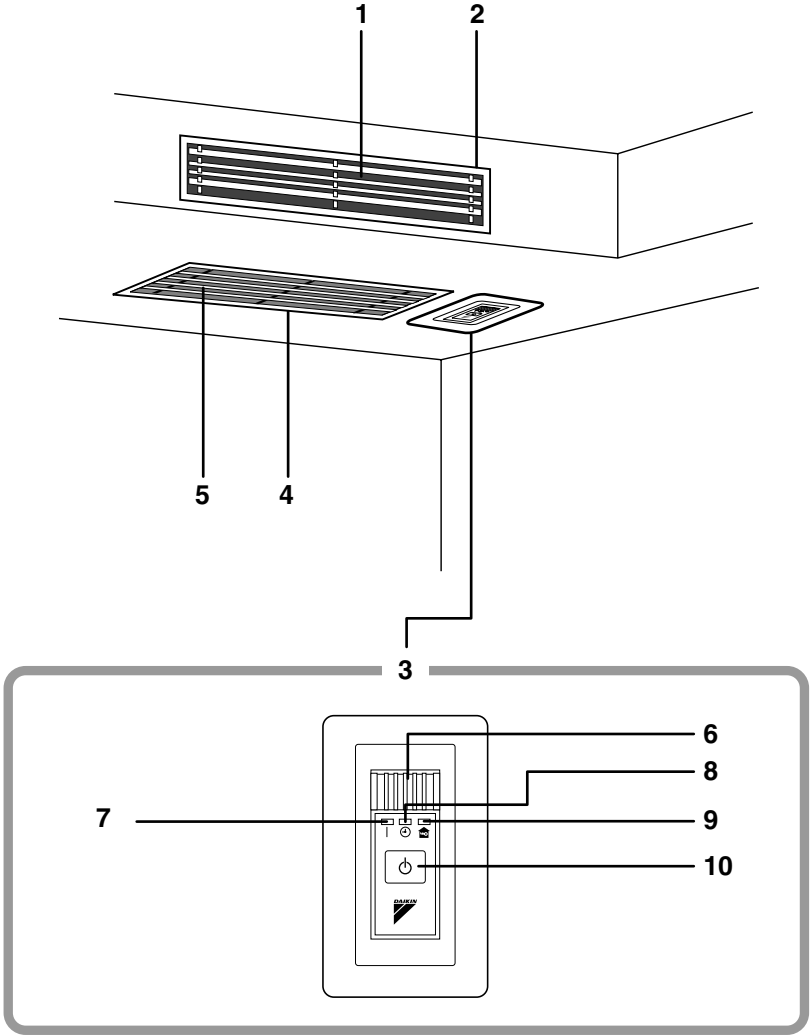

■ Outdoor Unit

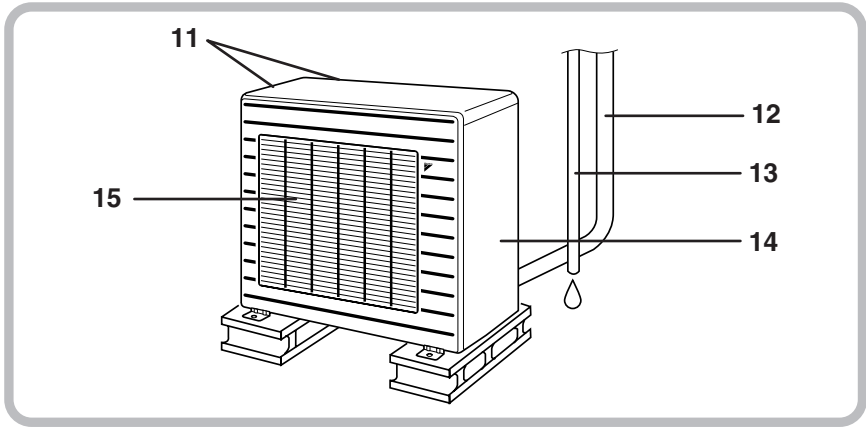

■ Indoor Unit

1. Air outlet

2. Air outlet grille: (Field supply)

- Appearance of the Air outlet grille and Air inlet grille may differ with some models.

3. Display, Control panel

4. Suction grille: (Option)

- Appearance of the suction grille and Air inlet grille may differ with some models.

5. Air inlet

6. Room temperature sensor:

- It senses the air temperature around the unit.

7. Operation lamp (green)

8. TIMER lamp (yellow): (page 16.)

9. HOME LEAVE lamp (red):

- Lights up when you use HOME LEAVE operation. (page 14.)

10. Indoor Unit ON/OFF switch:

- Push this switch once to start operation. Push once again to stop it.
- This switch is useful when the remote controller is missing.

- The operation mode refers to the following table.

	Mode	Temperature setting	Air flow rate
F(C)DKS	COOL	22°C	AUTO
F(C)DXS	AUTO	25°C	AUTO

■ Outdoor Unit

11. Air inlet: (Back and side)

12. Refrigerant piping and inter-unit cable

13. Drain hose

Appearance of the outdoor unit may differ from some models.

14. Earth terminal:

- It is inside of this cover.

15. Air outlet

■ Remote Controller

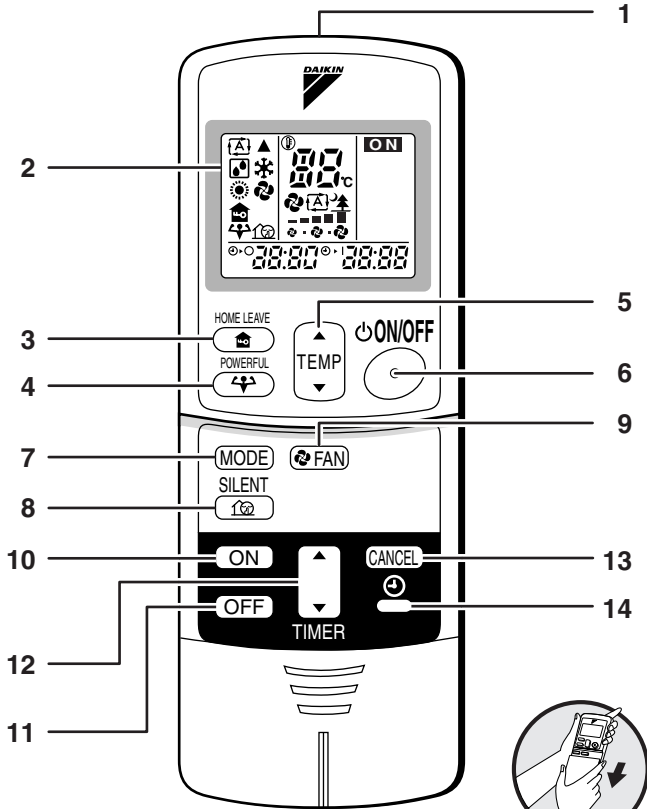

< ARC433A7, A8 >

1. Signal transmitter:

- It sends signals to the indoor unit.

2. Display:

- It displays the current settings.
(In this illustration, each section is shown with all its displays ON for the purpose of explanation.)

3. HOME LEAVE button:

for HOME LEAVE operation (page 14.)

4. POWERFUL button:

for POWERFUL operation (page 12.)

5. TEMPERATURE adjustment buttons:

- It changes the temperature setting.

6. ON/OFF button:

- Press this button once to start operation.
Press once again to stop it.

7. MODE selector button:

- It selects the operation mode.
(AUTO/DRY/COOL/HEAT/FAN) (page 10.)

8. SILENT button: for OUTDOOR UNIT SILENT operation (page 13.)

9. FAN setting button:

- It selects the air flow rate setting.

10. ON TIMER button: (page 17.)

11. OFF TIMER button: (page 16.)

12. TIMER Setting button:

- It changes the time setting.

13. TIMER CANCEL button:

- It cancels the timer setting.

14. CLOCK button: (page 9.)



Preparation Before Operation

■ To set the batteries

1. Press  with a finger and slide the front cover to take it off.
2. Set two dry batteries (AAA).
3. Set the front cover as before.

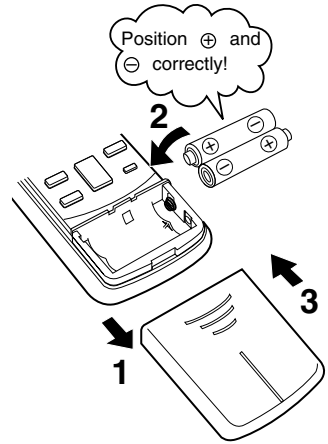

ATTENTION

■ About batteries

- When replacing the batteries, use batteries of the same type, and replace the two old batteries together.
- When the system is not used for a long time, take the batteries out.
- We recommend replacing once a year, although if the remote controller display begins to fade or if reception deteriorates, please replace with new alkali batteries. Using manganese batteries reduces the lifespan.
- The attached batteries are provided for the initial use of the system.
The usable period of the batteries may be short depending on the manufactured date of the air conditioner.

Preparation Before Operation

■ To operate the remote controller

- To use the remote controller, aim the transmitter at the indoor unit. If there is anything to block signals between the unit and the remote controller, such as a curtain, the unit will not operate.
- Do not drop the remote controller. Do not get it wet.
- The maximum distance for communication is about 4 m.

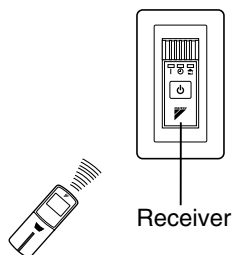

■ To fix the remote controller holder on the wall

1. Choose a place from where the signals reach the unit.
2. Fix the holder to a wall, a pillar, etc. with the screws supplied with the holder.
3. Place the remote controller in the remote controller holder.

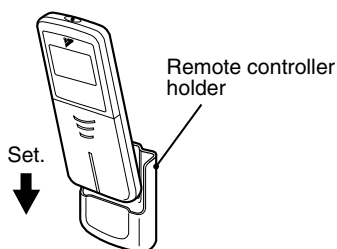

- To remove, pull it upwards.

ATTENTION

■ About remote controller

- Never expose the remote controller to direct sunlight.
- Dust on the signal transmitter or receiver will reduce the sensitivity. Wipe off dust with soft cloth.
- Signal communication may be disabled if an electronic-starter-type fluorescent lamp (such as inverter-type lamps) is in the room. Consult the shop if that is the case.
- If the remote controller signals happen to operate another appliance, move that appliance to somewhere else, or consult the shop.

■ To set the clock

1. Press “CLOCK button”.

0:00 is displayed.

⌚ blinks.

2. Press “TIMER setting button” to set the clock to the present time.

Holding down “▲” or “▼” button rapidly increases or decreases the time display.

3. Press “CLOCK button”.

⌚ blinks.

■ Turn the breaker ON

- Turning ON the breaker opens the flap, then closes it again. (This is a normal procedure.)

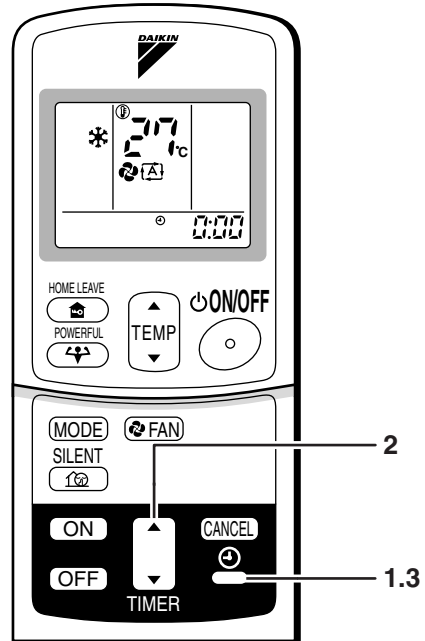

NOTE

■ Tips for saving energy

- Be careful not to cool (heat) the room too much. Keeping the temperature setting at a moderate level helps save energy.
- Cover windows with a blind or a curtain. Blocking sunlight and air from outdoors increases the cooling (heating) effect.
- Clogged air filters cause inefficient operation and waste energy. Clean them once in about every two weeks.

Recommended temperature setting

For cooling: 26°C – 28°C
For heating: 20°C – 24°C

■ Please note

- The air conditioner always consumes 15-35 watts of electricity even while it is not operating.
- If you are not going to use the air conditioner for a long period, for example in spring or autumn, turn the breaker OFF.
- Use the air conditioner in the following conditions.

Mode	Operating conditions	If operation is continued out of this range
COOL	Outdoor temperature: (2MK(X)S) 10 to 46 °C (3/4MK(X)S) –10 to 46 °C (RX(K)S) –10 to 46 °C Indoor temperature: 18 to 32 °C Indoor humidity: 80% max.	<ul style="list-style-type: none"> • A safety device may work to stop the operation. (In multi system, it may work to stop the operation of the outdoor unit only.) • Condensation may occur on the indoor unit and drip.
HEAT	Outdoor temperature: (2MXS) –10 to 21 °C (3/4MXS) –15 to 21 °C (RXS) –15 to 21 °C Indoor temperature: 10 to 30 °C	<ul style="list-style-type: none"> • A safety device may work to stop the operation.
DRY	Outdoor temperature: (2MK(X)S) 10 to 46 °C (3/4MK(X)S) –10 to 46 °C (RX(K)S) –10 to 46 °C Indoor temperature: 18 to 32 °C Indoor humidity: 80% max.	<ul style="list-style-type: none"> • A safety device may work to stop the operation. • Condensation may occur on the indoor unit and drip.

- Operation outside this humidity or temperature range may cause a safety device to disable the system.

AUTO · DRY · COOL · HEAT · FAN Operation

The air conditioner operates with the operation mode of your choice. From the next time on, the air conditioner will operate with the same operation mode.

■ To start operation

1. Press “MODE selector button” and select a operation mode.

- Each pressing of the button advances the mode setting in sequence.

: AUTO

: DRY

: COOL

: HEAT

: FAN

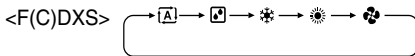
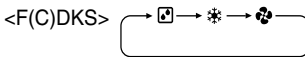

2. Press “ON/OFF button” .

- The OPERATION lamp lights up.

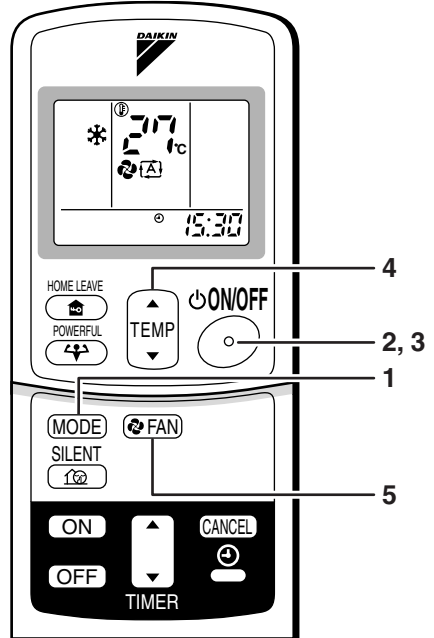
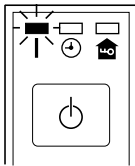

■ To stop operation

3. Press “ON/OFF button” again.

- Then OPERATION lamp goes off.





■ To change the temperature setting

4. Press “TEMPERATURE adjustment button”.

DRY or FAN mode	AUTO or COOL or HEAT mode
The temperature setting is not variable.	Press “▲” to raise the temperature and press “▼” to lower the temperature.
	Set to the temperature you like. 

■ To change the air flow rate setting

5. Press “FAN setting button”.

DRY mode	AUTO or COOL or HEAT or FAN mode
The air flow rate setting is not variable.	Five levels of air flow rate setting from “  ” to “  ” plus “  ” “  ” are available. 

- Indoor unit quiet operation

When the air flow is set to “”, the noise from the indoor unit will become quieter. Use this when making the noise quieter.

The unit might lose power when the fan strength is set to a weak level.

NOTE

■ Note on HEAT operation

- Since this air conditioner heats the room by taking heat from outdoor air to indoors, the heating capacity becomes smaller in lower outdoor temperatures. If the heating effect is insufficient, it is recommended to use another heating appliance in combination with the air conditioner.
- The heat pump system heats the room by circulating hot air around all parts of the room. After the start of heating operation, it takes some time before the room gets warmer.
- In heating operation, frost may occur on the outdoor unit and lower the heating capacity. In that case, the system switches into defrosting operation to take away the frost.
- During defrosting operation, hot air does not flow out of indoor unit.

■ Note on DRY operation

- The computer chip works to rid the room of humidity while maintaining the temperature as much as possible. It automatically controls temperature and fan strength, so manual adjustment of these functions is unavailable.

■ Note on AUTO operation

- In AUTO operation, the system selects a temperature setting and an appropriate operation mode (COOL or HEAT) based on the room temperature at the start of the operation.
- The system automatically reselects setting at a regular interval to bring the room temperature to user-setting level.
- If you do not like AUTO operation, you can manually select the operation mode and setting you like.

■ Note on air flow rate setting

- At smaller air flow rates, the cooling (heating) effect is also smaller.

POWERFUL Operation

POWERFUL operation quickly maximizes the cooling (heating) effect in any operation mode. You can get the maximum capacity.

■ To start POWERFUL operation

1. Press “POWERFUL button”.
 - POWERFUL operation ends in 20 minutes. Then the system automatically operates again with the settings which were used before POWERFUL operation.
 - When using POWERFUL operation, there are some functions which are not available.
 - “” is displayed on the LCD.

■ To cancel POWERFUL operation

2. Press “POWERFUL button” again.
 - “” disappears from the LCD.

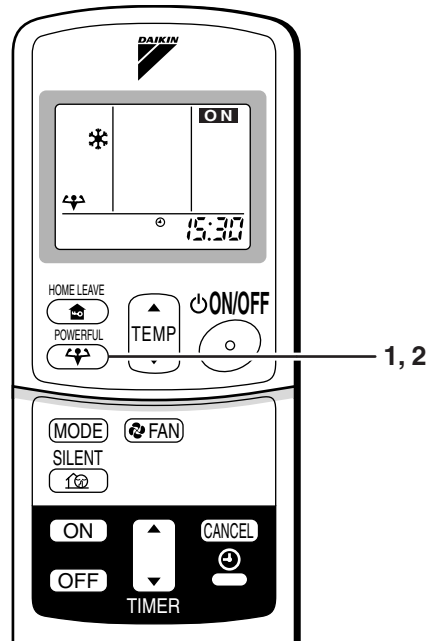

NOTE

■ Notes on POWERFUL operation

• In COOL and HEAT mode

To maximize the cooling (heating) effect, the capacity of outdoor unit must be increased and the air flow rate be fixed to the maximum setting. The temperature and air flow settings are not variable.

• In DRY mode

The temperature setting is lowered by 2.5°C and the air flow rate is slightly increased.

• In FAN mode

The air flow rate is fixed to the maximum setting.

• When using priority-room setting

See “Note for multi system” (page 19.)

OUTDOOR UNIT SILENT Operation

OUTDOOR UNIT SILENT operation lowers the noise level of the outdoor unit by changing the frequency and fan speed on the outdoor unit. This function is convenient during night.

■ To start OUTDOOR UNIT SILENT operation

1. Press “SILENT button”.
 - “” is displayed on the LCD.

■ To cancel OUTDOOR UNIT SILENT operation

2. Press “SILENT button” again.
 - “” disappears from the LCD.

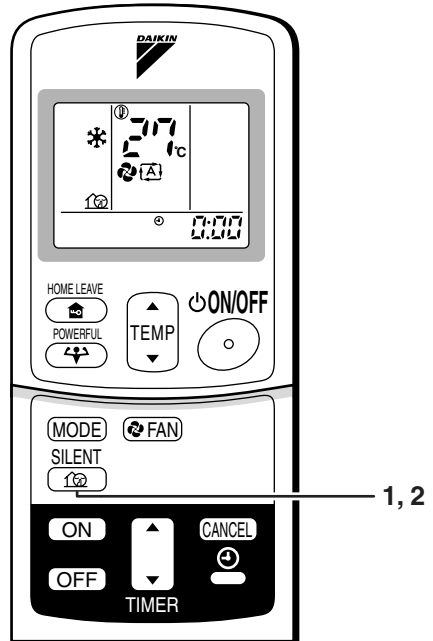

NOTE

■ Note on OUTDOOR UNIT SILENT operation

- If using a multi system, this function will work only when the OUTDOOR UNIT SILENT operation is set on all operated indoor units. However, if using priority-room setting, see “Note for multi system” (page 19.)
- This function is available in COOL, HEAT, and AUTO modes. (This is not available in FAN and DRY mode.)
- POWERFUL operation and OUTDOOR UNIT SILENT operation cannot be used at the same time. Priority is given to POWERFUL operation.
- If operation is stopped using the remote controller or the main unit ON/OFF switch when using OUTDOOR UNIT SILENT operation, “” will remain on the remote controller display.

HOME LEAVE Operation

HOME LEAVE operation is a function which allows you to record your preferred temperature and air flow rate settings.

■ To start HOME LEAVE operation

1. Press “HOME LEAVE button”.
 - “” is displayed on the LCD.
 - The HOME LEAVE lamp lights up.

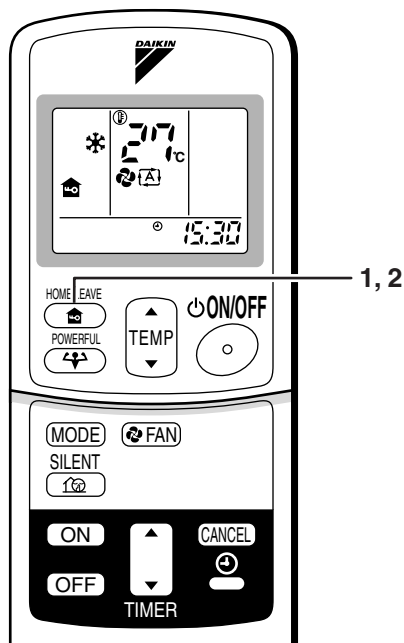
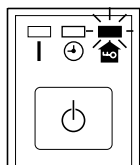

■ To cancel HOME LEAVE operation

2. Press “HOME LEAVE button” again.
 - The HOME LEAVE lamp goes off.
 - “” disappears from the LCD.

Before using HOME LEAVE operation.

■ To set the temperature and air flow rate for HOME LEAVE operation

When using HOME LEAVE operation for the first time, please set the temperature and air flow rate for HOME LEAVE operation. Record your preferred temperature and air flow rate.

	Initial setting		Selectable range	
	temperature	Air flow rate	temperature	Air flow rate
Cooling	25°C	AUTO	18-32°C	5 step, AUTO and SILENT
Heating	25°C	AUTO	10-30°C	5 step, AUTO and SILENT

1. Press “HOME LEAVE button”. Make sure “” is displayed in the remote control display.
2. Adjust the set temperature with “▲” or “▼” as you like.
3. Adjust the air flow rate with “FAN” setting button as you like.

Home leave operation will run with these settings the next time you use the unit. To change the recorded information, repeat steps 1 – 3.

■ What's the HOME LEAVE operation?

Is there a set temperature and air flow rate which is most comfortable, a set temperature and air flow rate which you use the most? HOME LEAVE operation is a function that allows you to record your favorite set temperature and air flow rate. You can start your favorite operation mode simply by pressing the HOME LEAVE button on the remote control. This function is convenient in the following situations.

■ Useful in these cases

1. Use as an energy-saving mode.

Set the temperature 2-3° higher (cooling) or lower (heating) than normal. Setting the fan strength to the lowest setting allows the unit to be used in energy-saving mode. Also convenient for use while you are out or sleeping.

• Every day before you leave the house...



When you go out, push the "HOME LEAVE Operation" button, and the air conditioner will adjust capacity to reach the preset temperature for HOME LEAVE Operation.



When you return, you will be welcomed by a comfortably air conditioned room.



Push the "HOME LEAVE Operation" button again, and the air conditioner will adjust capacity to the set temperature for normal operation.

• Before bed...



Set the unit to HOME LEAVE Operation before leaving the living room when going to bed.



The unit will maintain the temperature in the room at a comfortable level while you sleep.



When you enter the living room in the morning, the temperature will be just right. Disengaging HOME LEAVE Operation will return the temperature to that set for normal operation. Even the coldest winters will pose no problem!

2. Use as a favorite mode.

Once you record the temperature and air flow rate settings you most often use, you can retrieve them by pressing HOME LEAVE button. You do not have to go through troublesome remote control operations.

NOTE

- Once the temperature and air flow rate for HOME LEAVE operation are set, those settings will be used whenever HOME LEAVE operation is used in the future. To change these settings, please refer to the "Before using HOME LEAVE operation" section above.
- HOME LEAVE operation is only available in COOL and HEAT mode. Cannot be used in AUTO, DRY, and FAN mode.
- HOME LEAVE operation runs in accordance with the previous operation mode (COOL or HEAT) before using HOME LEAVE operation.
- HOME LEAVE operation and POWERFUL operation cannot be used at the same time. Last button that was pressed has priority.
- The operation mode cannot be changed while HOME LEAVE operation is being used.
- When operation is shut off during HOME LEAVE operation, using the remote controller or the indoor unit ON/OFF switch, "🏠" will remain on the remote controller display.

TIMER Operation

Timer functions are useful for automatically switching the air conditioner on or off at night or in the morning. You can also use OFF TIMER and ON TIMER in combination.

■ To use OFF TIMER operation

- Check that the clock is correct.
If not, set the clock to the present time.
(page 9.)

1. Press “OFF TIMER button”.

0:00 is displayed.

⊕-⊖ blinks.

2. Press “TIMER Setting button” until the time setting reaches the point you like.

- Every pressing of either button increases or decreases the time setting by 10 minutes. Holding down either button changes the setting rapidly.

3. Press “OFF TIMER button” again.

- The TIMER lamp lights up.

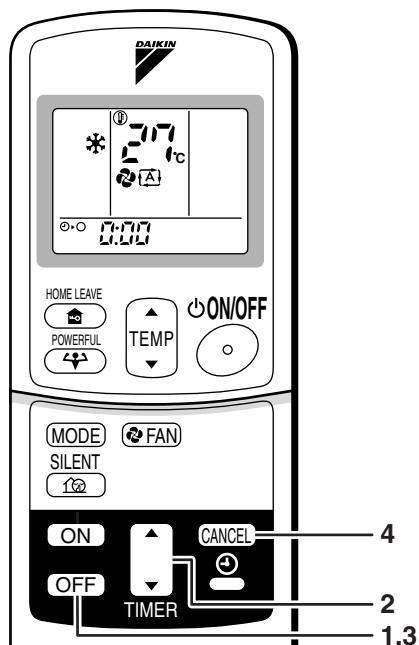
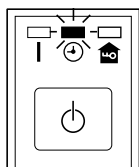

■ To cancel the OFF TIMER operation

4. Press “CANCEL button”.

- The TIMER lamp goes off.

NOTE

- When TIMER is set, the present time is not displayed.
- Once you set ON, OFF TIMER, the time setting is kept in the memory. (The memory is canceled when remote controller batteries are replaced.)
- When operating the unit via the ON/OFF Timer, the actual length of operation may vary from the time entered by the user. (Maximum approx. 10 minutes)

■ NIGHT SET MODE

When the OFF TIMER is set, the air conditioner automatically adjusts the temperature setting (0.5°C up in COOL, 2.0°C down in HEAT) to prevent excessive cooling (heating) for your pleasant sleep.

■ To use ON TIMER operation

- Check that the clock is correct. If not, set the clock to the present time (page 9.).

1. Press “ON TIMER button”.

7:00 is displayed.

⊙ - | blinks.

2. Press “TIMER Setting button” until the time setting reaches the point you like.

- Every pressing of either button increases or decreases the time setting by 10 minutes. Holding down either button changes the setting rapidly.

3. Press “ON TIMER button” again.

- The TIMER lamp lights up.

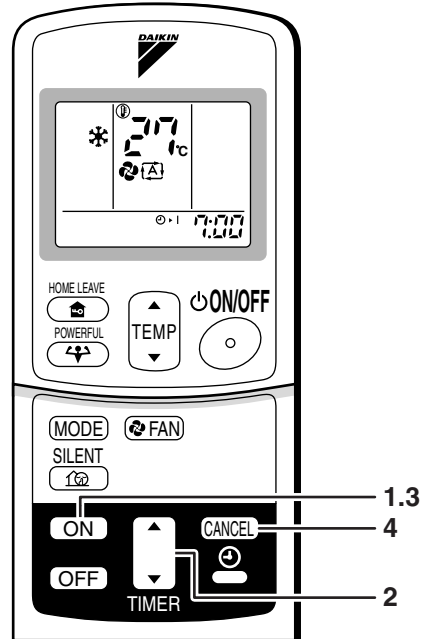
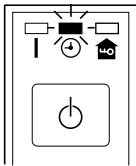

■ To cancel ON TIMER operation

4. Press “CANCEL button”.

- The TIMER lamp goes off.

■ To combine ON TIMER and OFF TIMER

- A sample setting for combining the two timers is shown below.

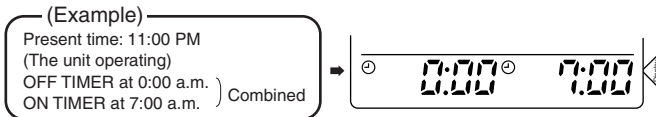

ATTENTION

■ In the following cases, set the timer again.

- After a breaker has turned OFF.
- After a power failure.
- After replacing batteries in the remote controller.

Note for Multi System

《《 What is a “Multi System”? 》》

This system has one outdoor unit connected to multiple indoor units. Functions depend on the model. See the list of functions and applicable models (*2) on the next page.

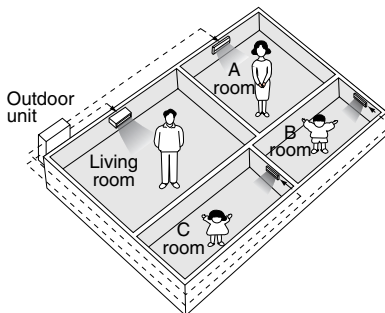

■ Selecting the Operation Mode

1. With the Priority Room Setting present but inactive or not present.

When more than one indoor unit is operating, priority is given to the first unit that was turned on.

In this case, set the units that are turned on later to the same operation mode (*1) as the first unit.

Otherwise, they will enter the Standby Mode, and the operation lamp will flash; this does not indicate malfunction.

(*1)

- COOL, DRY and FAN mode may be used at the same time.
- AUTO mode automatically selects COOL mode or HEAT mode based on the room temperature. Therefore, AUTO mode is available when selecting the same operation mode as that of the room with the first unit to be turned on.

(CAUTION)

Normally, the operation mode in the room where the unit is first run is given priority, but the following situations are exceptions, so please keep this in mind.

If the operation mode of the first room is **FAN Mode**, then using **Heating Mode** in any room after this will give priority to **heating**. In this situation, the air conditioner running in FAN Mode will go on standby, and the operation lamp will flash.

2. With the Priority Room Setting active.

See “Priority Room Setting” on the next page.

■ NIGHT QUIET Mode (Available only for cooling operation)

NIGHT QUIET Mode requires initial programming during installation. Please consult your retailer or dealer for assistance. NIGHT QUIET Mode reduces the operation noise of the outdoor unit during the night time hours to prevent annoyance to neighbors.

- The NIGHT QUIET Mode is activated when the temperature drops 5°C or more below the highest temperature recorded that day. Therefore, when the temperature difference is less than 5°C, this function will not be activated.
- NIGHT QUIET Mode reduces slightly the cooling efficiency of the unit.

■ OUTDOOR UNIT SILENT Operation (page 13.)

1. With the Priority Room Setting present but inactive or not present.

When using the OUTDOOR UNIT SILENT operation feature with the Multi system, set all indoor units to OUTDOOR UNIT SILENT operation using their remote controllers.

When clearing OUTDOOR UNIT SILENT operation, clear one of the operating indoor units using their remote controller. However OUTDOOR UNIT SILENT operation display remains on the remote controller for other rooms.

We recommend you release all rooms using their remote controllers.

2. With the Priority Room Setting active.

See “Priority Room Setting” on the next page.

■ Cooling / Heating Mode Lock (Available only for heat pump models)

The Cooling / Heating Mode Lock requires initial programming during installation. Please consult your retailer or dealer for assistance. The Cooling / Heating Mode Lock sets the unit forcibly to either Cooling or Heating Mode. This function is convenient when you wish to set all indoor units connected to the Multi system to the same operation mode.

■ Priority Room Setting

The Priority Room Setting requires initial programming during installation. Please consult your retailer or dealer for assistance.

The room designated as the Priority Room takes priority in the following situations;

1. Operation Mode Priority.

As the operation mode of the Priority Room takes precedence, the user can select a different operation mode from other rooms.

(Example)

* Room A is the Priority Room in the examples.

When COOL mode is selected in Room A while operating the following modes in Room B,C and D :

Operation mode in Room B, C and D	Status of Room B, C and D when the unit in Room A is in COOL mode
COOL or DRY or FAN	Current operation mode maintained
HEAT	The unit enters Standby Mode. Operation resumes when the Room A unit stops operating.
AUTO	If the unit is set to COOL mode, operation continues. If set to HEAT mode, it enters Standby Mode. Operation resumes when the Room A unit stops operating.

2. Priority when POWERFUL operation is used.

(Example)

* Room A is the Priority Room in the examples.

The indoor units in Rooms A,B,C and D are all operating. If the unit in Room A enters POWERFUL operation, operation capacity will be concentrated in Room A. In such a case, the cooling (heating) efficiency of the units in Rooms B,C and D may be slightly reduced.

3. Priority when using OUTDOOR UNIT SILENT operation.

(Example)

* Room A is the Priority Room in the examples.

Just by setting the unit in Room A to SILENT operation, the air conditioner starts OUTDOOR UNIT SILENT operation.

You don't have to set all the operated indoor units to SILENT operation.

■ Maximum Power Input Limitation

- The Maximum Power Input Limitation needs to be set when the unit is installed. Contact DAIKIN dealer.
- This function limits the power input of the unit to 1700W. It is recommended for locations with low-capacity circuit breakers.

(*2) List of functions and applicable models

	2MKS / 2AMKS	2MXS / 2AMXS	3MKS	3MXS	4MKS	4MXS
Priority Room Setting	—	—	○	○	○	○
NIGHT QUIET Mode	—	—	○	○	○	○
Cooling/Heating Mode Lock	—	—	—	○	—	○
Maximum Power Input Limitation	○	—	○	—	—	—

○ Function available

— Function unavailable

NOTE

- Cooling capacity will drop if the Maximum Power Input Limitation is used.

Care and Cleaning



CAUTION • Only a qualified service person is allowed to perform maintenance.

- Before cleaning, be sure to stop the operation and turn the breaker OFF.

■ Cleaning the air filter

1. Removing the air filter.

- Rear suction
Pull the bottom side of the air filter backwards, over the 3 bends.
- Bottom suction
Pull the filter over the 3 bends situated at the backside of the unit.

2. Cleaning the air filter.

Remove dust from the air filter using a vacuum cleaner and gently rinse them in cool water. Do not use detergent or hot water to avoid filter shrinking or deformation. After cleaning dry them in the shade.

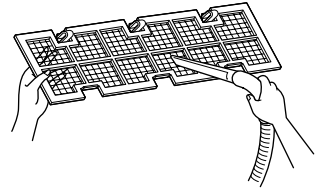

3. Replacing the air filter.

- Rear suction
Hook the filter behind the flap situated at the top of the unit and push the other side gently over the 3 bends.
- Bottom suction
Hook the filter behind the flap situated at the middle of the unit and push the other side gently over the 3 bends.

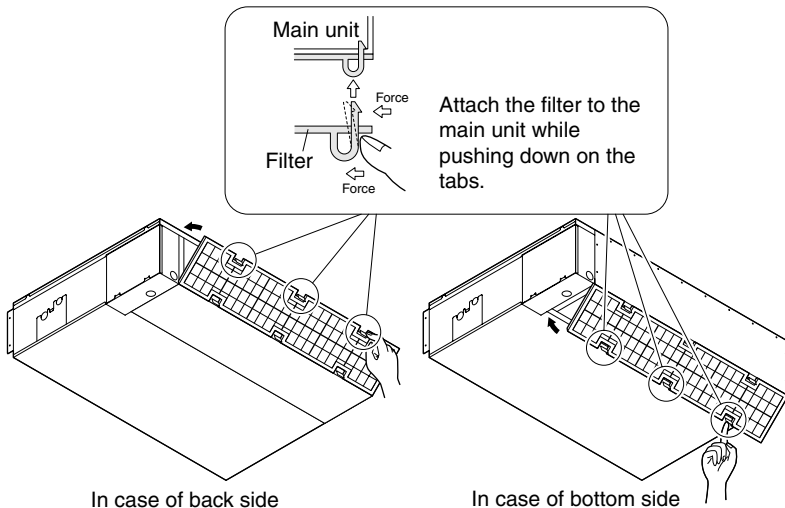

■ Cleaning the drain pan

- Clean the drain pan periodically, or drain piping may be clogged with dust and may result in water leakage. Ask your DAIKIN dealer to clean them.
- Prepare a cover locally to prevent any dust in the air around the indoor unit from getting in the drain pan, if there is a great deal of dust present.

CAUTION

- Do not operate the air conditioner without filters, this to avoid dust accumulation inside the unit.
- Do not remove the air filter except when cleaning. Unnecessary handling may damage the filter.
- Do not use gasoline, benzene, thinner, polishing powder, liquid insecticide, It may cause discoloring or warping.
- Do not let the indoor unit get wet. It may cause an electric shock or a fire.
- Operation with dusty air filters lowers the cooling and heating capacity and wastes energy.
- The suction grille is option.
- Do not use water or air of 50°C or higher for cleaning air filters and outside panels.

Check

Check that the base, stand and other fittings of the outdoor unit are not decayed or corroded.
Check that nothing blocks the air inlets and the outlets of the indoor unit and the outdoor unit.
Check that the earth wire is not disconnected or broken.
Check that the drain comes smoothly out of the drain hose during COOL or DRY operation. <ul style="list-style-type: none">• If no drain water is seen, water may be leaking from the indoor unit. Stop operation and consult the service shop if this is the case.

■ Before a long idle period

- 1. Operate the “FAN only” for several hours on a fine day to dry out the inside.**
 - Press “MODE selector button” and select “FAN” operation.
 - Press “ON/OFF button” and start operation.
- 2. Clean the air filters and set them again.**
- 3. Take out batteries from the remote controller.**
- 4. Turn OFF the breaker for the room air conditioner.**
 - When a multi outdoor unit is connected, make sure the heating operation is not used at the other room before you use the fan operation. (page 18.)

Trouble Shooting

These cases are not troubles.

The following cases are not air conditioner troubles but have some reasons. You may just continue using it.

Case	Explanation
Operation does not start soon. <ul style="list-style-type: none"> When ON/OFF button was pressed soon after operation was stopped. When the mode was reselected. 	<ul style="list-style-type: none"> This is to protect the air conditioner. You should wait for about 3 minutes.
Hot air does not flow out soon after the start of heating operation.	<ul style="list-style-type: none"> The air conditioner is warming up. You should wait for 1 to 4 minutes. (The system is designed to start discharging air only after it has reached a certain temperature.)
The heating operation stops suddenly and a flowing sound is heard.	<ul style="list-style-type: none"> The system is taking away the frost on the outdoor unit. You should wait for about 3 to 8 minutes.
The outdoor unit emits water or steam.	<ul style="list-style-type: none"> In HEAT mode <ul style="list-style-type: none"> The frost on the outdoor unit melts into water or steam when the air conditioner is in defrost operation. In COOL or DRY mode <ul style="list-style-type: none"> Moisture in the air condenses into water on the cool surface of outdoor unit piping and drips.
Mists come out of the indoor unit.	<ul style="list-style-type: none"> This happens when the air in the room is cooled into mist by the cold air flow during cooling operation.
The indoor unit gives out odour.	<ul style="list-style-type: none"> This happens when smells of the room, furniture, or cigarettes are absorbed into the unit and discharged with the air flow. (If this happens, we recommend you to have the indoor unit washed by a technician. Consult the service shop where you bought the air conditioner.)
The outdoor fan rotates while the air conditioner is not in operation.	<ul style="list-style-type: none"> After operation is stopped: <ul style="list-style-type: none"> The outdoor fan continues rotating for another 30 seconds for system protection. While the air conditioner is not in operation: <ul style="list-style-type: none"> When the outdoor temperature is very high, the outdoor fan starts rotating for system protection.
The operation stopped suddenly. (OPERATION lamp is on.)	<ul style="list-style-type: none"> For system protection, the air conditioner may stop operating on a sudden large voltage fluctuation. It automatically resumes operation in about 3 minutes.

Check again.

Please check again before calling a repair person.

Case	Check
The air conditioner does not operate. (OPERATION lamp is off.)	<ul style="list-style-type: none"> • Hasn't a breaker turned OFF or a fuse blown? • Isn't it a power failure? • Are batteries set in the remote controller? • Is the timer setting correct?
Cooling (Heating) effect is poor.	<ul style="list-style-type: none"> • Are the air filters clean? • Is there anything to block the air inlet or the outlet of the indoor and the outdoor units? • Is the temperature setting appropriate? • Are the windows and doors closed? • Are the air flow rate and the air direction set appropriately?
Operation stops suddenly. (OPERATION lamp blinks.)	<ul style="list-style-type: none"> • Are the air filters clean? • Is there anything to block the air inlet or the outlet of the indoor and the outdoor units? Clean the air filters or take all obstacles away and turn the breaker OFF. Then turn it ON again and try operating the air conditioner with the remote controller. If the lamp still blinks, call the service shop where you bought the air conditioner. • Are operation modes all the same for indoor units connected to outdoor units in the multi system? If not, set all indoor units to the same operation mode and confirm that the lamps blink. Moreover, when the operation mode is in "AUTO", set all indoor unit operation modes to "COOL" or "HEAT" for a moment and check again that the lamps are normal. If the lamps stop blinking after the above steps, there is no malfunction. (page 18.)
An abnormal functioning happens during operation.	<ul style="list-style-type: none"> • The air conditioner may malfunction with lightning or radio waves. Turn the breaker OFF, turn it ON again and try operating the air conditioner with the remote controller.

Call the service shop immediately.

WARNING

- When an abnormality (such as a burning smell) occurs, stop operation and turn the breaker OFF.
Continued operation in an abnormal condition may result in troubles, electric shocks or fire.
Consult the service shop where you bought the air conditioner.
- Do not attempt to repair or modify the air conditioner by yourself.
Incorrect work may result in electric shocks or fire.
Consult the service shop where you bought the air conditioner.

If one of the following symptoms takes place, call the service shop immediately.

- **The power cord is abnormally hot or damaged.**
- **An abnormal sound is heard during operation.**
- **The safety breaker, a fuse, or the earth leakage breaker cuts off the operation frequently.**
- **A switch or a button often fails to work properly.**
- **There is a burning smell.**
- **Water leaks from the indoor unit.**

Turn the breaker
OFF and call the
service shop.

- **After a power failure**
The air conditioner automatically resumes operation in about 3 minutes. You should just wait for a while.

- **Lightning**
If lightning may strike the neighbouring area, stop operation and turn the breaker OFF for system protection.

Disposal requirements



Your air conditioning product is marked with this symbol. This means that electrical and electronic products shall not be mixed with unsorted household waste.

Do not try to dismantle the system yourself: the dismantling of the air conditioning system, treatment of the refrigerant, of oil and of other parts must be done by a qualified installer in accordance with relevant local and national legislation.

Air conditioners must be treated at a specialized treatment facility for re-use, recycling and recovery. By ensuring this product is disposed of correctly, you will help to prevent potential negative consequences for the environment and human health. Please contact the installer or local authority for more information.

Batteries must be removed from the remote controller and disposed of separately in accordance with relevant local and national legislation.

We recommend periodical maintenance.

In certain operating conditions, the inside of the air conditioner may get foul after several seasons of use, resulting in poor performance. It is recommended to have periodical maintenance by a specialist aside from regular cleaning by the user. For specialist maintenance, contact the service shop where you bought the air conditioner.

The maintenance cost must be born by the user.

Fault diagnosis.

FAULT DIAGNOSIS BY REMOTE CONTROLLER

In the ARC433A series, the temperature display sections on the main unit indicate corresponding codes.

1. When the **TIMER CANCEL** button is held down for 5 seconds, a “**00**” indication flashes on the temperature display section.

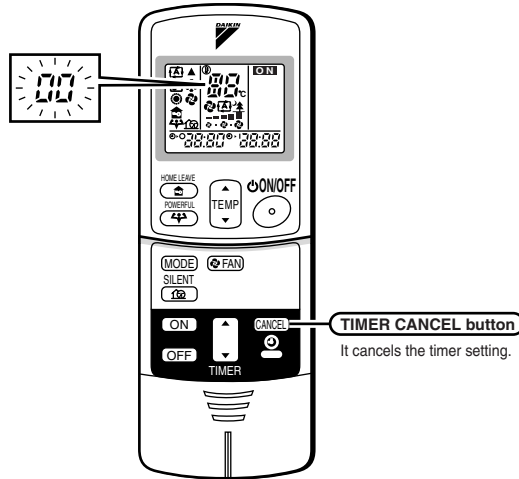

2. Press the **TIMER CANCEL** button repeatedly until a continuous beep is produced.

- The code indication changes in the sequence shown below, and notifies with along beep.

	CODE	MEANING
SYSTEM	00	NORMAL
	U0	REFRIGERANT SHORTAGE
	U2	DROP VOLTAGE OR MAIN CIRCUIT OVERVOLTAGE
	U4	FAILURE OF TRANSMISSION (BETWEEN INDOOR UNIT AND OUTDOOR UNIT)
INDOOR UNIT	A1	INDOOR PCB DEFECTIVENESS
	A5	HIGH PRESSURE CONTROL OR FREEZE-UP PROTECTOR
	A6	FAN MOTOR FAULT
	C4	FAULTY HEAT EXCHANGER TEMPERATURE SENSOR
OUTDOOR UNIT	C9	FAULTY SUCTION AIR TEMPERATURE SENSOR
	EA	COOLING-HEATING SWITCHING ERROR
	E5	OL STARTED
	E6	FAULTY COMPRESSOR START UP
	E7	DC FAN MOTOR FAULT
	E8	OPERATION HALT DUE TO DETECTION OF INPUT OVER CURRENT
	F3	HIGH TEMPERATURE DISCHARGE PIPE CONTROL
	F6	HIGH PRESSURE CONTROL (IN COOLING)
	H6	OPERATION HALT DUE TO FAULTY POSITION DETECTION SENSOR
	H8	CT ABNORMALITY
	H9	FAULTY SUCTION AIR TEMPERATURE SENSOR
	J3	FAULTY DISCHARGE PIPE TEMPERATURE SENSOR
	J6	FAULTY HEAT EXCHANGER TEMPERATURE SENSOR
	L4	HIGH TEMPERATURE AT INVERTER CIRCUIT HEATSINK
L5	OUTPUT OVERCURRENT	
P4	FAULTY INVERTER CIRCUIT HEATSINK TEMPERATURE SENSOR	

NOTE

1. A short beep and two consecutive beeps indicate non-corresponding codes.
2. To cancel the code display, hold the **TIMER CANCEL** button down for 5 seconds. The code display also cancel itself if the button is not pressed for 1 minute.

LED ON OUTDOOR UNIT PCB 3MXS, 3MKS, 4MXS, 4MKS series

GREEN	RED				
MICROCOMPUTER NORMAL	MALFUNCTION DETECTION				
LED-A	LED1	LED2	LED3	LED4	DIAGNOSIS
●	●	●	●	●	NORMAL → CHECK INDOOR UNIT
⚡	⚡	●	⚡	⚡	HIGH PRESSURE PROTECTOR WORKED OR FREEZE-UP IN OPERATING UNIT OR STAND-BY UNIT
⚡	⚡	●	⚡	●	* OVERLOAD RELAY WORKED OR HIGH DISCHARGE PIPE TEMPERATURE
⚡	●	⚡	⚡	●	FAULTY COMPRESSOR START
⚡	●	⚡	●	⚡	INPUT OVERCURRENT
⚡	⚡	⚡	●	●	* THERMISTOR OR CT ABNORMALITY
⚡	⚡	⚡	●	⚡	HIGH TEMPERATURE SWITCHBOX
⚡	●	●	●	⚡	HIGH TEMPERATURE AT INVERTER CIRCUIT HEATSINK
⚡	●	●	⚡	●	* OUTPUT OVERCURRENT
⚡	●	●	⚡	⚡	* REFRIGERANT SHORTAGE
⚡	⚡	●	●	⚡	LOW VOLTAGE TO MAIN CIRCUIT OR MOMENTARY VOLTAGE LOSS
⚡	⚡	●	●	●	REVERSING SOLENOID VALVE SWITCHING FAILURE
⚡	⚡	⚡	⚡	⚡	FAN MOTOR FAULT
⚡	–	–	–	–	[NOTE 1]
●	–	–	–	–	POWER SUPPLY FAULT OR [NOTE 2]

GREEN	NORMALLY FLASHING
RED	NORMALLY OFF
⚡	ON
⚡	FLASHING
●	OFF
–	IRRELEVANT

LED ON OUTDOOR UNIT PCB 2MXS, 2MKS series

GREEN	
MICROCOMPUTER NORMAL	
LED-A	DIAGNOSIS
⚡	NORMAL → CHECK INDOOR UNIT
⚡	[NOTE 1]
●	POWER SUPPLY FAULT OR [NOTE 2]

GREEN	NORMALLY FLASHING
⚡	ON
⚡	FLASHING
●	OFF

NOTE

1. Turn the power off and then on again. If the LED display recurs, the outdoor unit PCB is faulty.
2. Diagnosis marked
 - * Do not apply to some cases. For details, refer to the service guide.

DAIKIN INDUSTRIES, LTD.

Head office:

Umeda Center Bldg., 4-12, Nakazaki-Nishi 2-chome,
Kita-ku, Osaka, 530-8323 Japan

Tokyo office:

JR Shinagawa East Bldg., 18-1, Konan
2-chome, Minato-ku, Tokyo, 108-0075 Japan
<http://www.daijin.com/global/>

DAIKIN EUROPE NV

Zandvoordestraat 300, B-8400 Oostende, Belgium