



INSTALLATION MANUAL

Wired Remote Control

MWR-SH00

System Air Conditioner

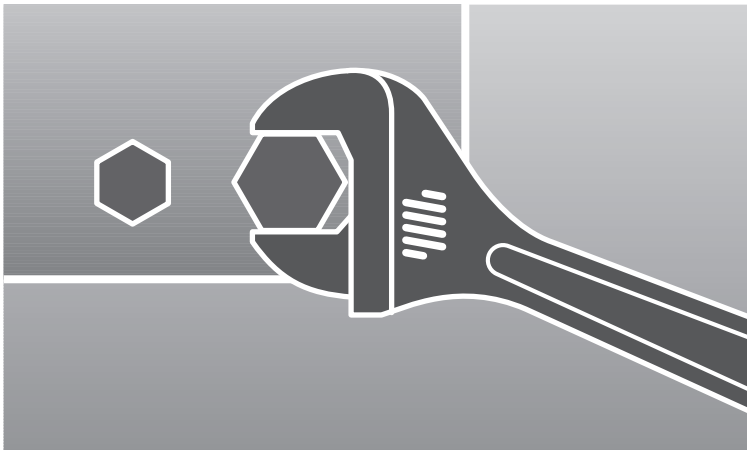

Safety Precautions

This installation manual describes how to install the wired remote control.

For installation of other optional accessories, refer to the appropriate installation manual.



WARNING

- ◆ Read carefully this installation manual before installation and check if the wired remote control is installed correctly after installation.
- ◆ Do not attempt to install or repair this wired remote control by yourself.
- ◆ This wired remote control contains no user-serviceable parts. Always consult authorized service personnel for repairs.
- ◆ When moving, consult authorized service personnel for disconnection and installation of the wired remote control.
- ◆ Ensure that the wall is strong enough to support the weight of the wired remote control.
- ◆ Must install the wired remote control with rated power supply.
- ◆ The wired remote control must be installed according to the national electrical rules by an installation specialist.
- ◆ If you wish to uninstall the wired remote control, consult an authorized installation center.



CAUTION

- ◆ Do not use inflammable gases near the wired remote control.
- ◆ Do not install the wired remote control in a location where it will come into contact with combustible gases, machine oil, sulphide gas, etc.
- ◆ Avoid locations where acid/alkali solution or special spray is used.
- ◆ Choose a location that is dry and sunny, but not exposed to direct sunlight. Suitable temperature is between 0°C and 39°C.
- ◆ Do not spill water into the wired remote control.
- ◆ Do not apply tensile strength to the cable to avoid cable damage.
- ◆ Do not press the buttons with a sharp object.
- ◆ Do not connect the power cable to the control terminal.
- ◆ If the wired remote control is installed in a hospital or other special places, it should not affect other electronic devices.

Contents

- ◆ **WIRED REMOTE CONTROL AND ACCESSORIES** 4
 - Accessories 4
- ◆ **INSTALLING THE WIRED REMOTE CONTROL** 5
 - Installation 5
 - Setting the Wired Remote Control Options 6
 - Wired Remote Control Error Codes 6
 - Connecting the Wired Remote Control 7

Note

- ◆ The illustrations will help you to understand the symbols displayed in the pictures.
- ◆ The illustrations in the step-by-step procedures use 3 different symbols:

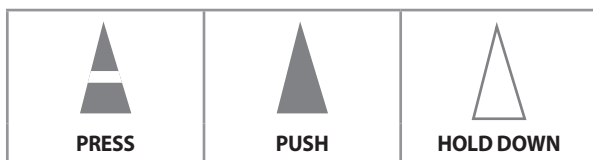





Wired Remote Control and Accessories

Accessories

The following accessories are supplied with the air conditioner.

- ◆ The number of each accessory is indicated in parentheses.

Cable Tie (2) 	Cable Clamp (2) 	M4X16 Screw (2) 	User's manual (1) 	Installation manual(1) 
--	--	--	--	--

Caution

- ◆ **The wired remote control should be installed by a trained installer.**
- ◆ **Make sure the main power is off before installing the wired remote control.**
- ◆ **The cables must be installed according to the national wiring regulations and inside the wall for safety reasons.**
- ◆ **Always separate the communication cable and the power cable to avoid malfunction of the unit. (Connecting the power cable to the communication terminal of the wired remote control will cause serious damage to the wired remote control. Make sure the wires are connected to the appropriate terminals.)**

Installing the Wired Remote Control

Installation

Connect the power cables and communication cables of the wired remote control to the terminal of indoor unit PCB.

- 1 Open the wired remote control by using the groove on its top.
- 2 Secure the rear cover of the wired remote control to the wall with 2 screws.
- 3 Connect the V1, V2 terminal of the wired remote control to the V1, V2 terminal of the indoor unit.
- 4 Connect the F3, F4 terminal of the wired remote control to the F3, F4 terminal of the indoor unit.
- 5 Reassemble the wired remote control.

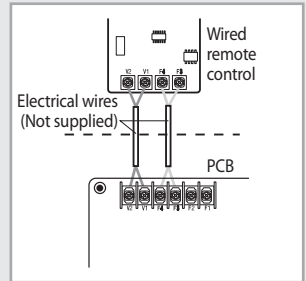
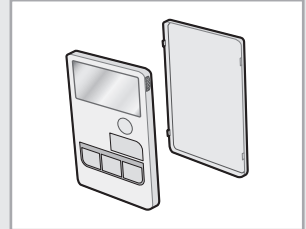

Installing the Wired Remote Control (Continued)

* Default setting

SW1 SW2 SW3 SW4 SW5 SW6 SW7 SW8



DIP 601

Setting the Wired Remote Control Options

Switch No.	Switch OFF	Switch ON
SW1	Cooling and Heating	Cooling Only
SW2	Temp. display : °C	Temp. display : °F
SW3	Allow wireless remote control	Disable the wireless remote control
SW4	-	-
SW5	-	-
SW6	-	-
SW7	-	-
SW8	Master remote control	Slave remote control

Wired Remote Control Error Codes

- The error codes of the indoor and outdoor units are displayed on the wired remote control. Refer to the indoor and outdoor unit technical manuals for the error codes reference.
- The following error codes are related to the wired remote control.

Display	Explanation	Remark
E01	Wired remote control ↔ Indoor unit communication error	-
E02	Master ↔ Slave wired remote control communication error	When using 2 wired remote controls to control one indoor unit.
E03	Communication packet error	-
E04	Wired remote control tracking error No indoor units found	-
E05	7 Day scheduler error	-
E06	COM1/COM2 installation error	-
E07	COM2 dual master error	-
E18	Excessive indoor unit installation error	-
E19	Temperature units (Celsius/Fahrenheit) mixed setting error of installed indoor units	-
E20	Temperature units (Celsius/Fahrenheit) setting error	-
E21	Master/Slave DIP option setting error	-

Connecting the Wired Remote Control

Individual Control

- ◆ Using one wired remote control for one indoor unit.

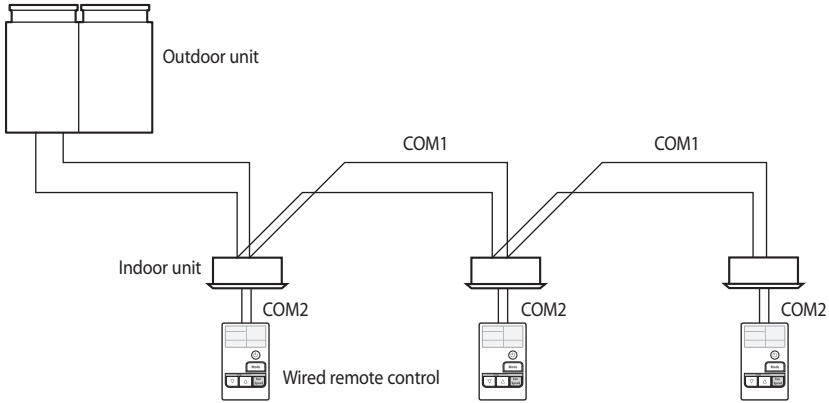

Note The wired remote control can be only installed on COM2.

Installing the Wired Remote Control (Continued)

Connecting the Wired Remote Control

Group Control

- ◆ Using one wired remote control for a group of indoor units.

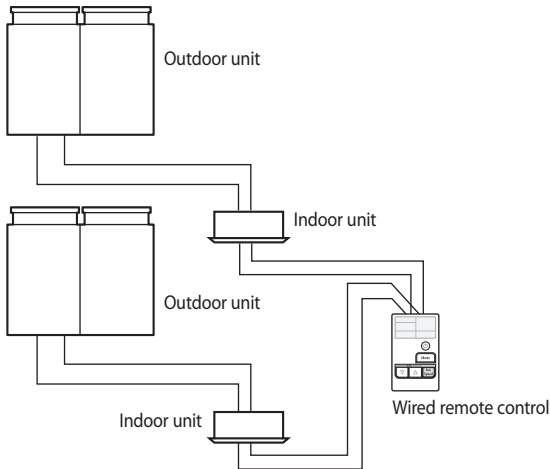
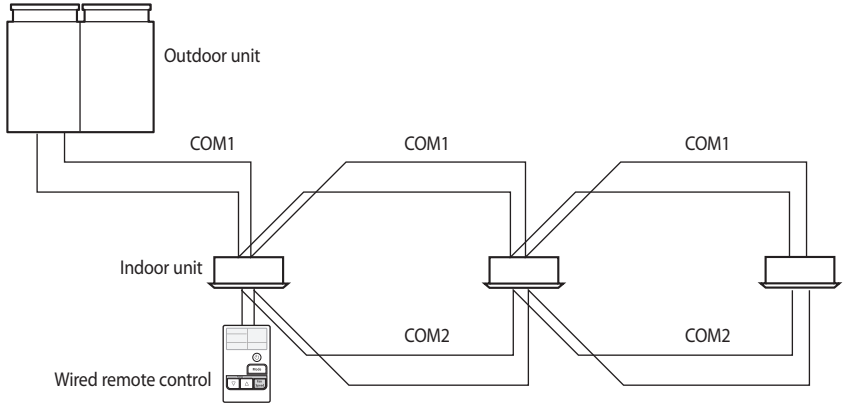

Note

- ◆ Indoor units connected to different outdoor units can be controlled as a group.
- ◆ At most 16 indoor units may be controlled as a group.

Using 2 wired remote controls

- ◆ 2 wired remote controls can be used to control a single indoor unit or a group of indoor units.

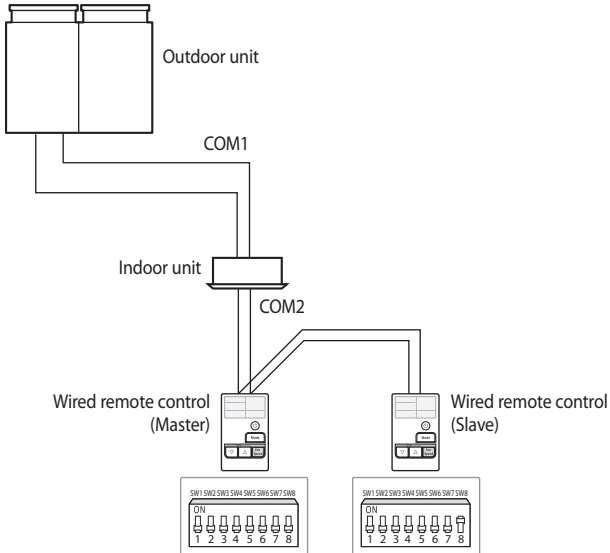



A series of horizontal dotted lines for writing, spanning the width of the page. The lines are evenly spaced and extend from the left margin to the right margin. There are 20 dotted lines in total, providing ample space for notes or a memo.



ELECTRONICS